

SinglFuse™ SF-0603S Series Features

- Single blow fuse for overcurrent protection
- 1608 (EIA 0603) miniature footprint
- Slow blow fuse
- UL certified
- RoHS compliant* and halogen free**
- Thin film chip fuse
- Surface mount packaging for automated assembly

SF-0603S Series - Slow Blow Surface Mount Fuses

Electrical Characteristics

Model	Rated Current (Amps)	Fusing Time	Resistance (mΩ) Typ.***	Rated Voltage	Breaking Capacity	Typical I ² t (A ² s)
SF-0603S050	0.50	Open within 5 sec. at 250 % rated current	175	DC 50 V	DC 50 V 50 A	0.009
SF-0603S063	0.63		130	DC 32 V	DC 32 V 50 A	0.017
SF-0603S080	0.80		93			0.024
SF-0603S100	1.00		65			0.026
SF-0603S125	1.25		47			0.057
SF-0603S150	1.50		36			0.081
SF-0603S160	1.60		34			0.086
SF-0603S200	2.00		26			0.115
SF-0603S250	2.50		20			0.200
SF-0603S300	3.00		16			0.210
SF-0603S315	3.15		15			0.279
SF-0603S400	4.00		12			0.326
SF-0603S500	5.00		9			0.622

***Resistance value was measured with less than 10 % of rated current.

Reliability Testing

Parameter	Requirement	Test Method
Carrying Capacity.....	No fusing.....	Rated current, 4 hours
Fusing Time.....	Within 5 seconds.....	250 % of its rated current
Interrupting Ability.....	No mechanical damages.....	After the fuse is interrupted, rated voltage applied for 30 seconds again
Bending Test.....	No mechanical damages.....	Distance between holding points: 90 mm, Bending: 3 mm, 1 time, 30 seconds
Resistance to Solder Heat.....	±20 %.....	260 °C ±5 °C, 10 seconds ±1 second
Solderability.....	95 % coverage minimum.....	235 °C ±5 °C, 2 ±0.5 second 245 °C ±5 °C, 2 ±0.5 second (lead free)
Temperature Rise.....	<75 °.....	100 % of its rated current, measure of surface temperature
Resistance to Dry Heat.....	±20 %.....	105 °C ±5 °C, 1000 hours
Resistance to Solvent.....	No evident damage on protective.....	23 °C ±5 °C of isopropyl alcohol, 90 seconds coating and marking
Residual Resistance.....	10k W or more.....	Measure DC resistance after fusing
Thermal Shock.....	DR < 10 %.....	-20 °C / +25 °C / +125 °C / +25 °C, 10 cycles

Typical Part Marking

Represents total content. Layout may vary.



RATING CURRENT (A)	
F = 0.50	S = 2.00
I = 0.63	T = 2.50
K = 0.80	3 = 3.00
L = 1.00	U = 3.15
M = 1.25	W = 4.00
P = 1.50	Y = 5.00
N = 1.60	

How to Order

SF - 0603 S 050 - 2

SinglFuse™ Product Designator	└──┬──┘
SMD Footprint 1608 (EIA 0603) size	└──┬──┘
Fuse Blow Type F = Fast acting S = Slow blow	└──┬──┘
Rated Current 050-500 (500 mA - 5.00 A)	└──┬──┘
Packaging Type - 2 = Tape & Reel (5,000 pcs./reel)	└──┬──┘

BOURNS®

Asia-Pacific:

Tel: +886-2 2562-4117
Fax: +886-2 2562-4116

Europe:

Tel: +41-41 768 5555
Fax: +41-41 768 5510

The Americas:

Tel: +1-951 781-5500
Fax: +1-951 781-5700

www.bourns.com

* RoHS Directive 2002/95/EC Jan 27 2003 including Annex.

** Bourns is using the definition that appears to be the prevalent definition used as the industry standard at this time. The Bourns definition of "halogen-free" is: Bromine (Br) content: ≤ 900 ppm; Chlorine (Cl) content: ≤ 900 ppm; Total Br + Cl content: ≤ 1500 ppm.

"SinglFuse" is a trademark of Bourns, Inc.

Specifications are subject to change without notice.

Customers should verify actual device performance in their specific applications.

SinglFuse™ SF-0603S Series Applications

- Portable memory
- LCD monitors
- Disk drives
- PDAs
- Digital cameras
- DVDs
- Cell phones
- Rechargeable battery packs
- Battery chargers
- Set top boxes
- Industrial controllers

SF-0603S Series - Slow Blow Surface Mount Fuses **BOURNS®**

Solder Reflow Recommendations

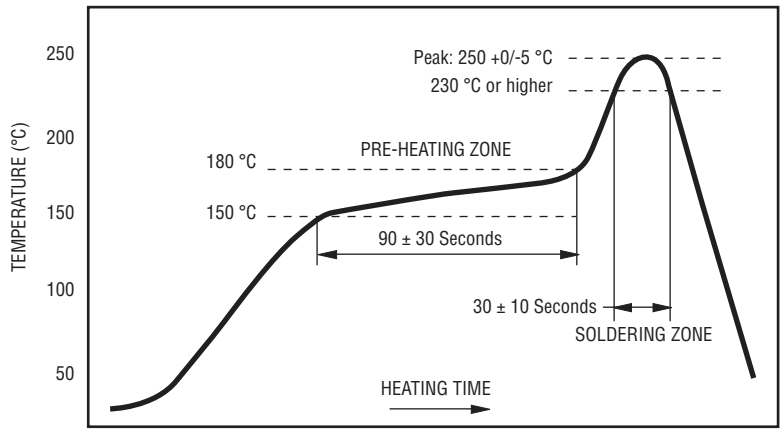

PEAK: 250 +0/-5 °C, 5 seconds
 PRE-HEATING ZONE: 150 to 180 °C, 90 ± 30 seconds
 SOLDERING ZONE: 230 °C or higher, 30 ± 10 seconds

Product Dimensions

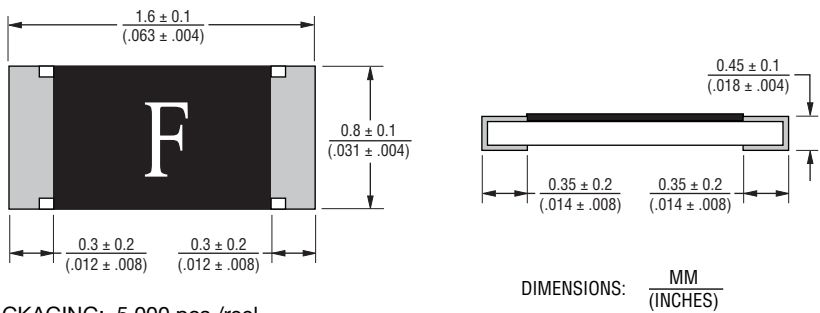

PACKAGING: 5,000 pcs./reel

Recommended Pad Layout

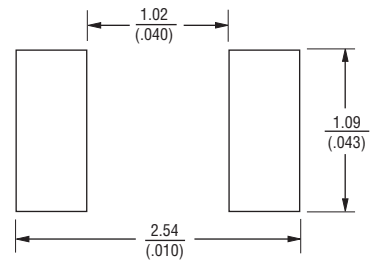

Thermal Derating Curve

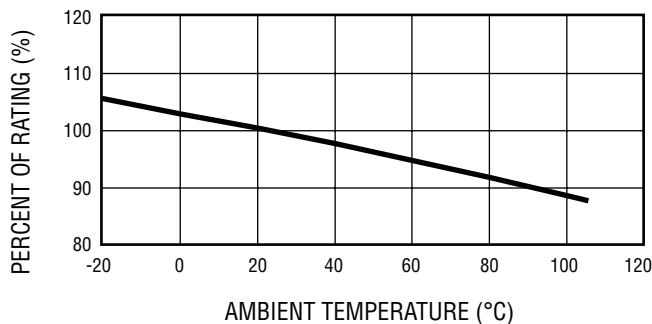

Operating Temperature.....-40 °C to +105 °C
 Storage Conditions
 Temperature +5 °C to +35 °C
 Humidity40 % to 75 %
 Shelf Life.....2 years from manufacturing date

Construction & Material Content

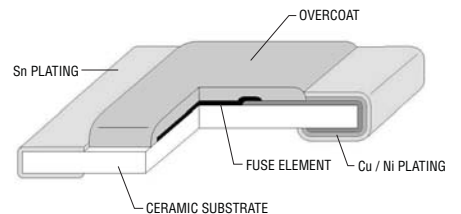

Specifications are subject to change without notice.
 Customers should verify actual device performance in their specific applications.

SF-0603S Series - Slow Blow Surface Mount Fuses

BOURNS®

Average Time Current Curves

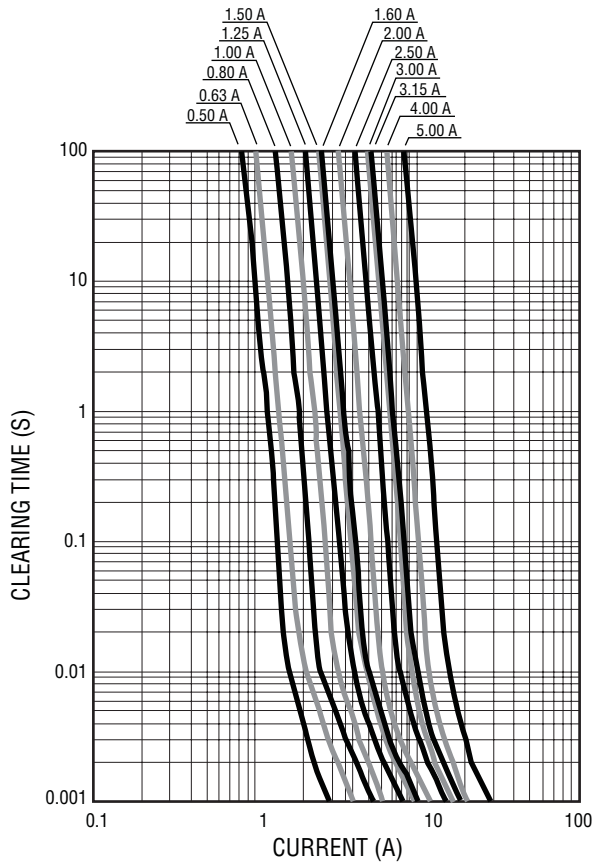

Minimum I²T V Clear Time Curves

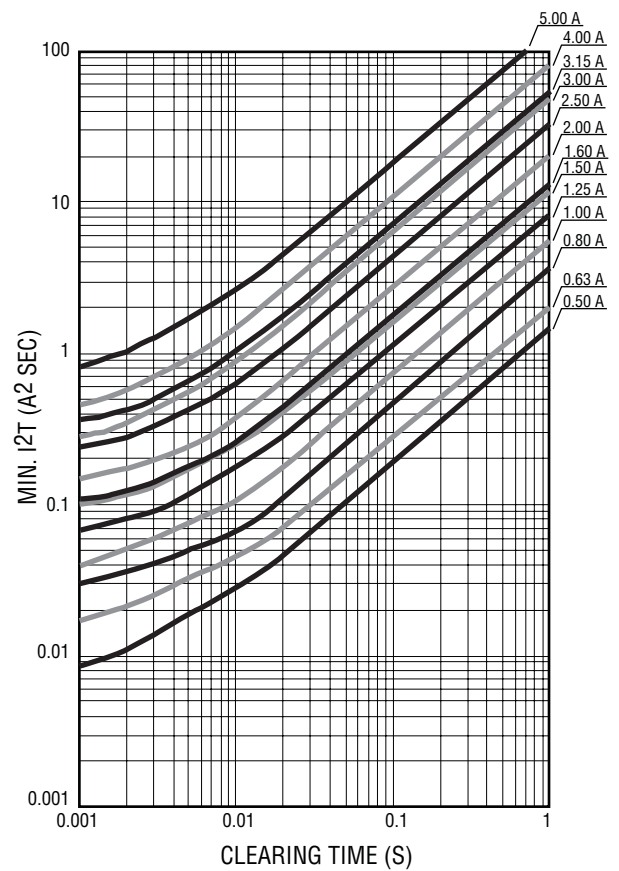

REV. D 12/20/10

Specifications are subject to change without notice.
Customers should verify actual device performance in their specific applications.

SF-0603S Series Tape and Reel Specifications

BOURNS®

Tape Dimensions	SF-0603S Series per EIA 481-2
W	$\frac{8.0 \pm 0.2}{(.315 \pm .008)}$
P ₀	$\frac{4.0 \pm 0.1}{(.157 \pm .004)}$
P ₁	$\frac{4.0 \pm 0.1}{(.157 \pm .004)}$
P ₂	$\frac{2.0 \pm 0.05}{(.079 \pm .002)}$
A	$\frac{1.1 \pm 0.1}{(.043 \pm .004)}$
B	$\frac{1.9 \pm 0.1}{(.075 \pm .004)}$
F	$\frac{3.5 \pm 0.05}{(.138 \pm .002)}$
E	$\frac{1.75 \pm 0.1}{(.069 \pm .004)}$
D ₀	$\frac{1.5 + 0.1/-0}{(.059 + .004/-0)}$
T	$\frac{0.64 \pm 0.1}{(.025 \pm .004)}$
Reel Dimensions	
A	$\frac{180 +0/-3.0}{(7.087 +0/- .118)}$
B Min.	$\frac{60.0}{(2.362)}$
C	$\frac{13.0 \pm 1.0}{(.512 \pm .039)}$
W	$\frac{9.0 \pm 1.0}{(.354 \pm .039)}$
T	$\frac{11.4 \pm 2.0}{(.449 \pm .079)}$

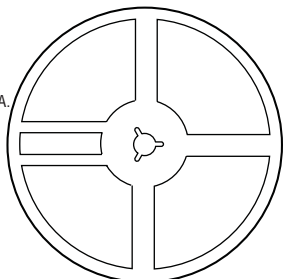
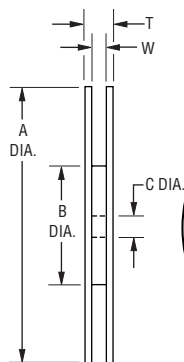

DIMENSIONS: $\frac{\text{MM}}{\text{(INCHES)}}$

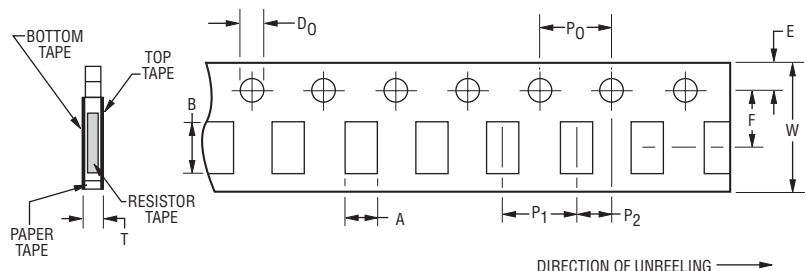

Specifications are subject to change without notice.
Customers should verify actual device performance in their specific applications.