

### RoHS HF 469 Series – 1206 Slo-Blo® Fuse

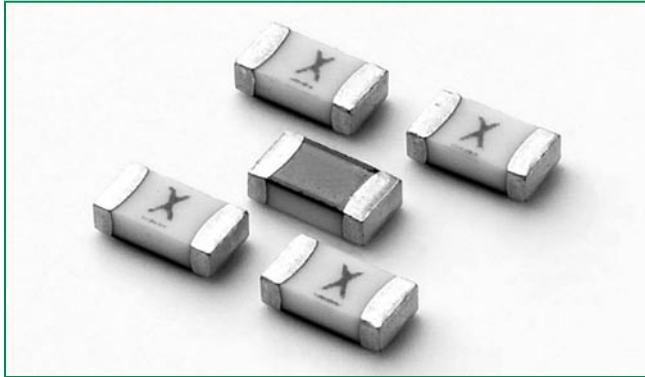

#### Description

The 469 Series is a 100% Lead-free, RoHS compliant and Halogen-free fuse series designed specifically to provide over-current protection to circuits that operate under high working ambient temperature up to 150°C.

The general design ensures excellent temperature stability and performance reliability.

The high I<sup>2</sup>t values which are typical in the Littelfuse Ceramic fuse family, ensure high inrush current withstand capability.



#### Features

- Operating Temperature from -55°C to +150°C
- Suitable for both leaded and lead-free reflow / wave soldering
- 100% Lead-free, RoHS compliant and Halogen-free

#### Applications

- Automotive Electronics
- LCD Displays
- Servers
- Notebook Computers
- Printers
- Scanners
- Data Modems
- Gaming Consoles



#### Agency Approvals

AGENCY	AGENCY FILE NUMBER	AMPERE RANGE
	E10480	1A – 8A
	LR29862	1A – 8A

#### Electrical Characteristics for Series

% of Ampere Rating	Ampere Rating	Opening Time at 25°C
100%	1A – 8A	4 hours, Minimum
200%	1A – 8A	1 sec., Min.; 120 secs., Max.
300%	1A – 8A	0.1 sec., Min.; 3 secs., Max.
800%	1A – 8A	0.002 sec., Min.; 0.05 sec., Max.

#### Electrical Specifications by Item

Ampere Rating (A)	Amp Code	Max. Voltage Rating (V)	Interrupting Rating	Nominal Resistance (Ohms) <sup>2</sup>	Nominal Melting I <sup>2</sup> t (A <sup>2</sup> Sec.) <sup>3</sup>	Nominal Voltage Drop At Rated Current (V) <sup>4</sup>	Nominal Power Dissipation At Rated Current (W)	Agency Approvals					
													
1	001.	63	50 A @ 63 V DC	COMING SOON				pending	pending				
1.25	1.25	63						pending	pending				
1.5	01.5	63						x	x				
2	002.	63						x	x				
2.5	02.5	32	50 A @ 32 V DC					x	x				
3	003.	32						x	x				
3.5	03.5	32						x	x				
4	004.	32	60 A @ 32 V DC					0.052	3.560	0.236	0.944	x	x
5	005.	32						0.035	5.620	0.216	1.080	x	x
6	006.	24	60 A @ 24 V DC					0.028	9.410	0.274	1.640	x	x
7	007.	24		0.021	14.400	0.216	1.510	x	x				
8	008.	24		0.017	23.720	0.233	1.860	x	x				

#### Notes:

1. AC Interrupting Rating tested at rated voltage with unity power factor. DC Interrupting Rating tested at rated voltage with time constant < 0.8 msec.
2. Nominal Resistance measured with < 10% rated current.
3. Nominal Melting I<sup>2</sup>t measured at 1 msec opening time.
4. Nominal Voltage Drop measured at rated current after temperature has stabilized.

Devices designed to carry rated current for 4 hours minimum. It is recommended that devices be operated continuously at no more than 80% rated current. See "Temperature Derating Curve" for additional derating information.

Devices designed to be mounted with marking code facing up.

### Temperature Derating Curve

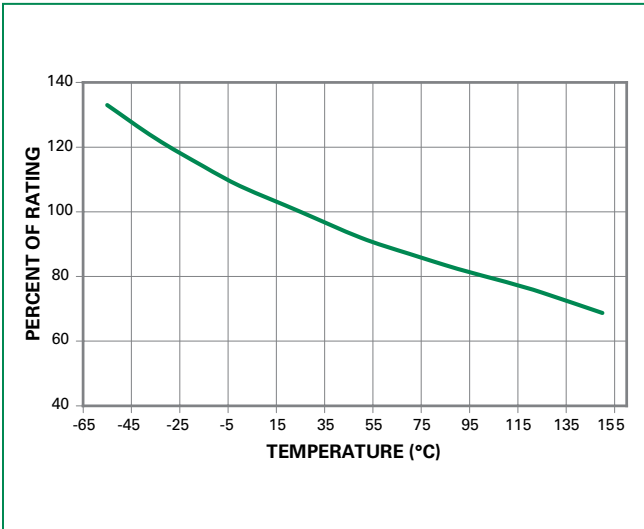

Note:

1. Derating depicted in this curve is in addition to the standard derating of 20% for continuous operation.

Example:

For continuous operation at 75 degrees celsius, the fuse should be derated as follows:

$$I = (0.80)(0.85)_{RAT} = (0.68)_{RAT}$$

### Average Time Current Curves

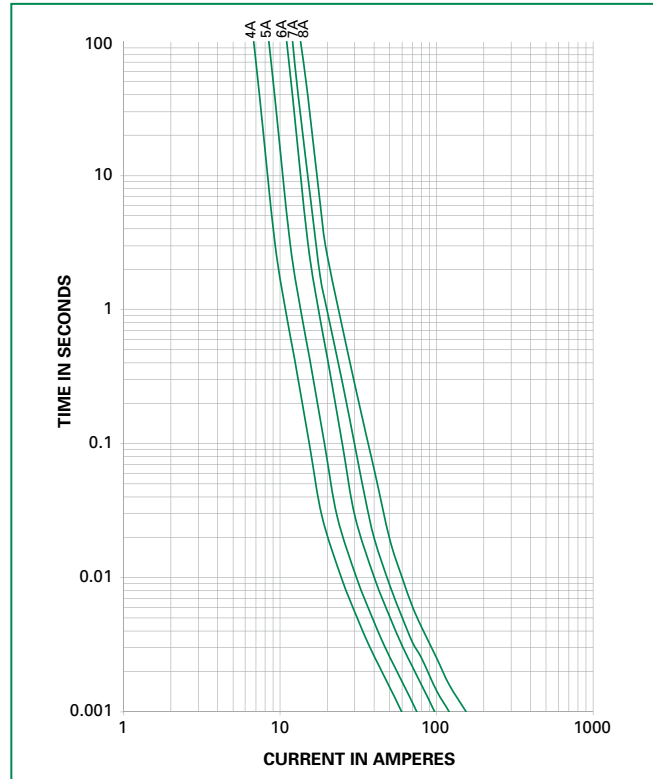

### Soldering Parameters

Reflow Condition	Pb – free assembly	
Pre Heat	- Temperature Min ( $T_{s(min)}$ )	150°C
	- Temperature Max ( $T_{s(max)}$ )	200°C
	- Time (Min to Max) ( $t_s$ )	60 – 180 seconds
Average Ramp-up Rate (Liquidus Temp ( $T_L$ ) to peak)	3°C/second max.	
$T_{s(max)}$ to $T_L$ - Ramp-up Rate	5°C/second max.	
Reflow	- Temperature ( $T_L$ ) (Liquidus)	217°C
	- Temperature ( $t_L$ )	60 – 150 seconds
Peak Temperature ( $T_p$ )	260 <sup>+0/-5</sup> °C	
Time within 5°C of actual peak Temperature ( $t_p$ )	10 – 30 seconds	
Ramp-down Rate	6°C/second max.	
Time 25°C to peak Temperature ( $T_p$ )	8 minutes max.	
Do not exceed	260°C	

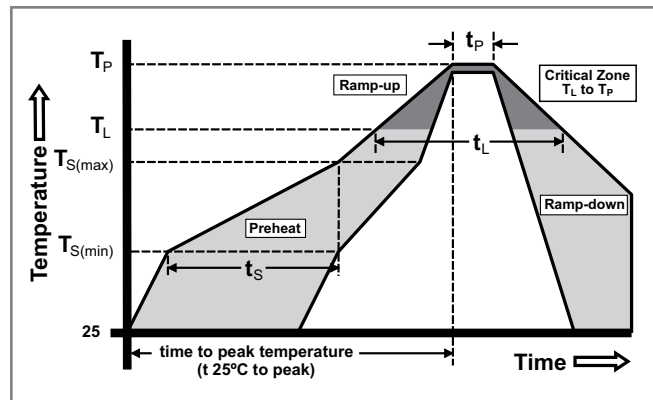

Wave Soldering	260°C, 10 seconds max.
----------------	------------------------

### Product Characteristics

<b>Materials</b>	<b>Body:</b> Advanced Ceramic <b>Terminations:</b> Ag / Ni / Sn (100% Lead-free) <b>Element Cover Coating:</b> Lead-free Glass
<b>Moisture Sensitivity Level</b>	IPC/JEDEC J-STD-020C, Level 1
<b>Solderability</b>	IPC/EIC/JEDEC J-STD-002B, Condition B
<b>Humidity Test</b>	MIL-STD-202, Method 103B, Conditions D
<b>Resistance to Solder Heat</b>	MIL-STD-202, Method 210F, Condition B

<b>Moisture Resistance</b>	MIL-STD-202, Method 106G
<b>Thermal Shock</b>	MIL-STD-202, Method 107G, Condition B
<b>Mechanical Shock</b>	MIL-STD-202, Method 213B, Condition A
<b>Vibration</b>	MIL-STD-202, Method 201A
<b>Vibration, High Frequency</b>	MIL-STD-202, Method 204D, Condition D
<b>Dissolution of Metallization</b>	IPC/EIC/JEDEC J-STD-002B, Condition D
<b>Terminal Strength</b>	IEC 60127-4

### Dimensions

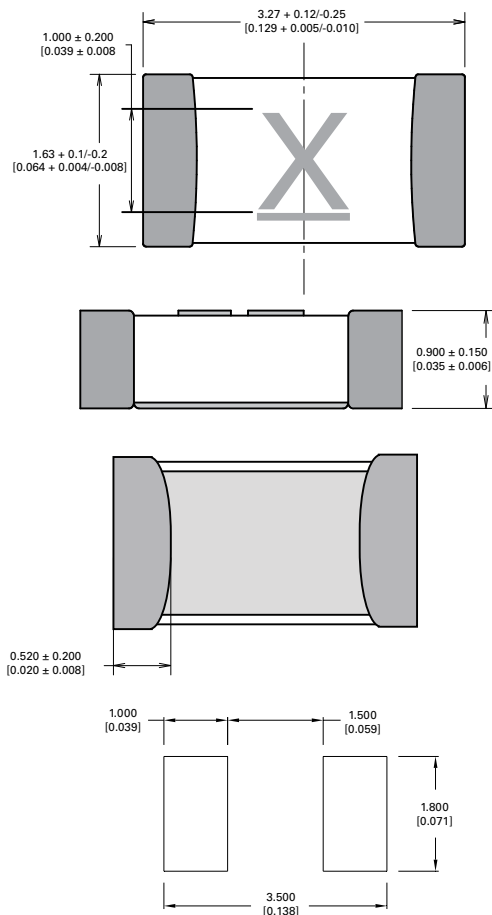

### Part Marking System

Amp Code	Marking Code
001.	<u>H</u>
1.25	<u>J</u>
01.5	<u>K</u>
002.	<u>N</u>
02.5	<u>O</u>
003.	<u>P</u>
03.5	<u>R</u>
004.	<u>S</u>
005.	<u>T</u>
006.	<u>U</u>
007.	<u>W</u>
008.	<u>X</u>

### Part Numbering System

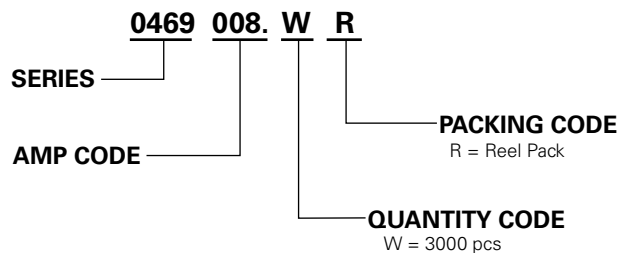

### Packaging

Packaging Option	Packaging Specification	Quantity	Quantity & Packaging Code
8mm Tape and Reel	EIA-481-1 (IEC 286, part 3)	3000	WR

