

E-T-A® Three-position switch 3131

Description

Single pole three-position switch with latching or momentary switch functions. Featuring a soft-touch contoured rocker actuator with optional illumination. The 3131 is sealed to provide IP66 rated front of panel water splash protection.

Typical applications

Household appliances, electrical tools, mobile homes, watercraft, construction vehicles, medical equipment

Ordering Information

Type number

3131 Single pole switch (3 positions)

Function

B 3-position switch single pole, switching function

D 3-position switch single pole, momentary switch function

E latching switch under window 1, momentary switch under window 2

F momentary switch under window 1, latching switch under window 2

Mounting

F flange mounting

Accessories

1 with sealing IP66

Terminal design

N blade terminals 2x2.8x0.8 EN 60934

Characteristic curve

Q switch only,

Actuator style

0 without actuator
rocker X3131-W... must be ordered separately

Actuator colour

0 without actuator

Rocker legends

00 without

Rocker marking

0 without

Orientation

0 without

Illumination

0 without

2 two LEDs, full illumination in position 1 and 2, dimmed illumination in position 0

Type of illumination

0 without illumination

T blue LED

Y yellow LED

Illumination voltage range

0 without illumination

2 10 - 14 V DC

3 20 - 32 V DC

Current ratings

20 A

3131 - B F 1 N Q - 0 0 00 0 0 - 2 Y 3 - 20A ordering example

Illumination voltage / power consumption

Operating voltage	Power consumption LED
12 V	10 mA
24 V	10 mA



3131
Three-position switch

Technical data

For further details please see chapter: Technical Information

Voltage rating	DC 32 V
Current rating	20 A
Typical life	30,000 operations at 1 x I _N , inductive
Ambient temperature	-20...+60 °C (-4...+140 °F)
Insulation co-ordination (IEC 60664)	2.5 kV/2 re-inforced insulation in the operating area
Dielectric strength operating area	test voltage AC 3,000 V
current path/current path	test voltage AC 1,500 V
Insulation resistance	> 100 MΩ (DC 500 V)
Protection class (IEC 60529)	operating area IP66 terminal area IP00
Vibration	5 g (57-500 Hz) ± 0.38 mm (10-57 Hz) test to IEC 60068-2-6, test Fc, 10 frequency cycles/axis
Shock	25 g (11 ms), test to IEC 60068-2-27, test Ea
Corrosion	96 hours at 5 % salt mist, test to IEC 60068-2-11, test Ka
Humidity	240 hours at 95 % RH, test to IEC 60068-2-78, test Cab
Mass	approx. 30 g

Approvals

Authority

UL 1500 Ignition Protected

1

Dimensions

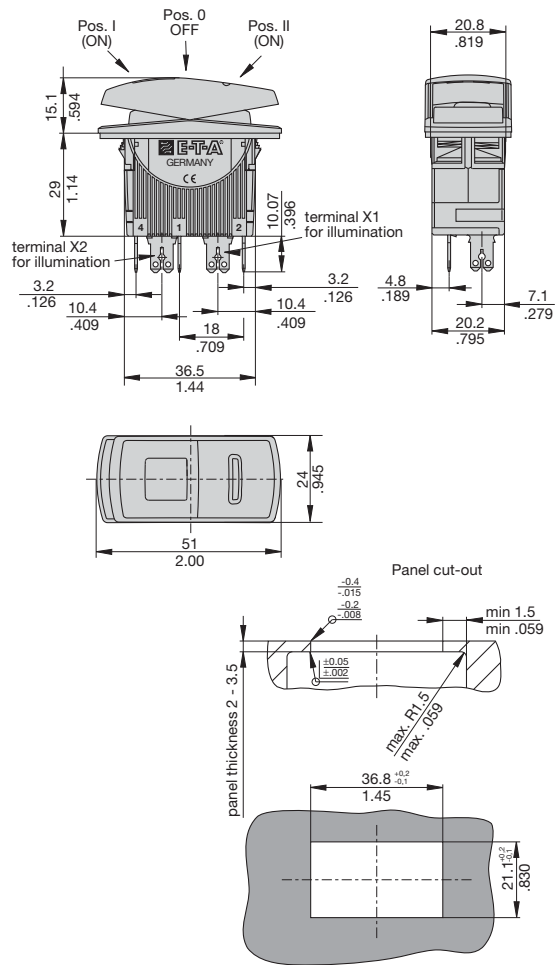

Internal connection diagrams

latching switch

without illumination

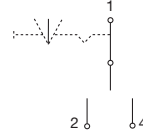

with illumination

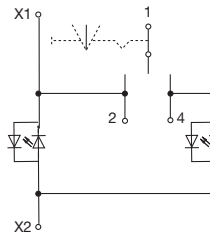

momentary switch

without illumination

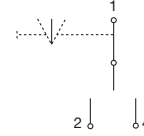

with illumination

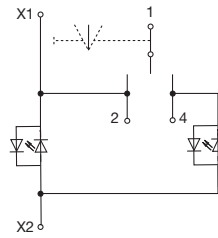



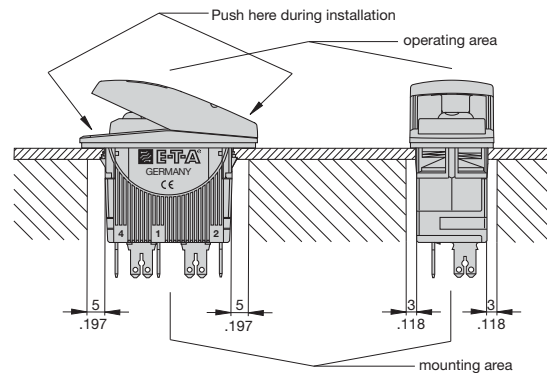



Installation drawing



This is a metric design and millimeter dimensions take precedence ($\frac{mm}{inch}$)

List of available legends

		Ordering information
Anchor		07
Windshield wiper		08
Bilge pump		09
Ventilation fan		12
Trim tabs		25
Mast lift		26
Further symbols upon request		

Ordering Information X3131-...

Type number	X3131	module for type 3131
Actuator style	W	rocker soft-touch, two illumination windows
Actuator colour	A	blue / white translucent
	B	black / white translucent
	C	skyblue / white translucent
Rocker legends	00	without
	...	see separate survey of legends
Rocker marking	0	without
	B	I and II
	C	◀ and ▶ (orientation 1 only)
Orientation	0	without orientation
	1	orientation 1 (standard)
	2	orientation 2
	3	orientation 3
	4	orientation 4
X3131 - W A 07 0 1 ordering example		

1

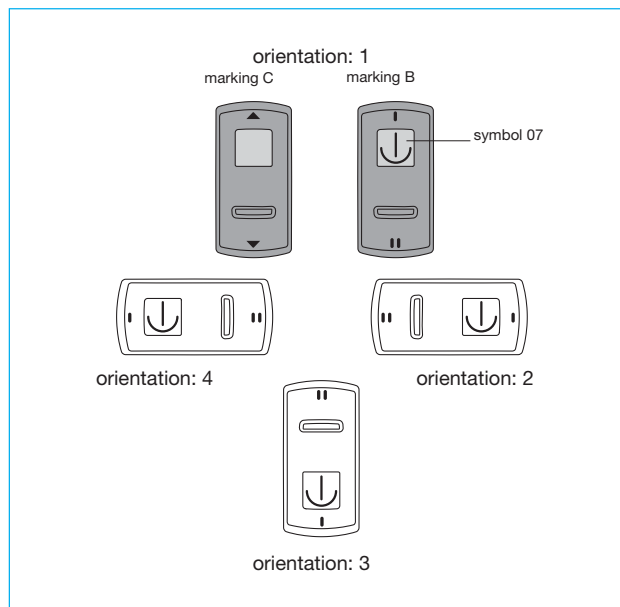

Accessories

1

Mounting frame

Consisting of a left- and right-side piece, can be expanded by a centre piece.

(Please order 2 side pieces per mounting frame)

The pieces firmly engage when stuck together.

side piece Y 308 790 01

centre piece Y 308 791 01

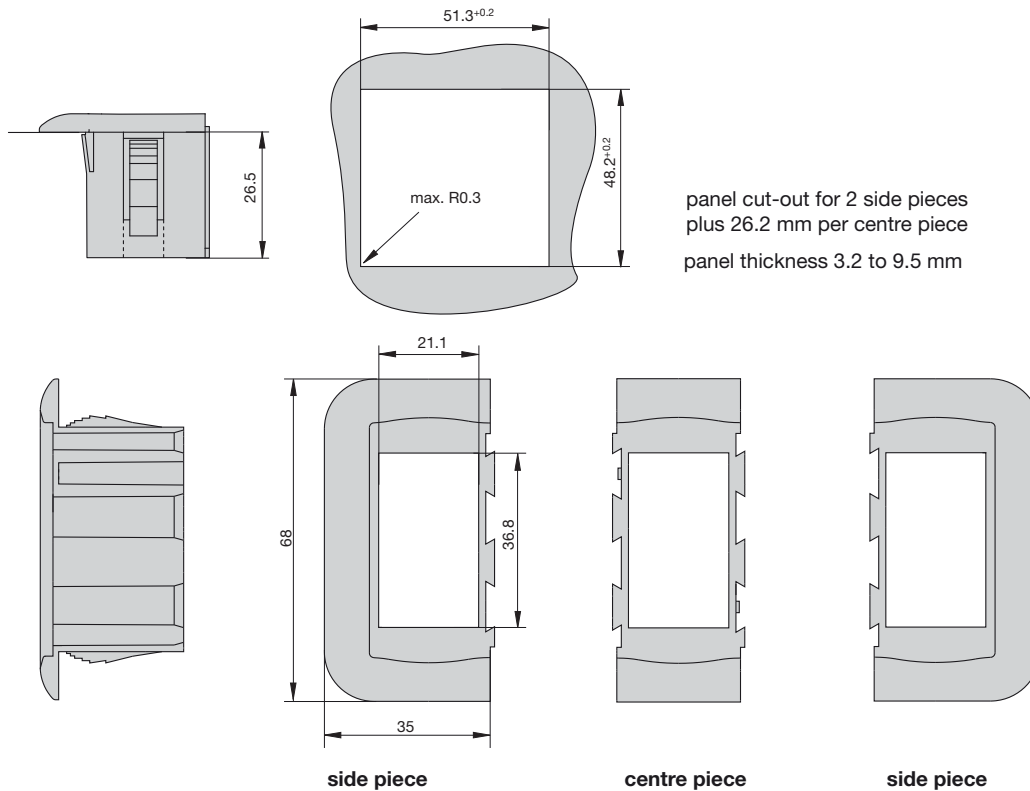

All dimensions without tolerances are for reference only. In the interest of improved design, performance and cost effectiveness the right to make changes in these specifications without notice is reserved. Product markings may not be exactly as the ordering codes. Errors and omissions excepted.