

Description

Single pole switch/thermal circuit breaker with push-push or push-to-reset actuation (S-type TO or R-type TO CBE to EN 60934) and tease-free, trip-free, snap action mechanism. Designed for snap-in panel mounting utilising round hole or industry standard fuse-holder cut-out dimensions. Featuring an ergonomically styled two colour actuator with indicator band clearly showing the tripped/OFF position. Approved to CBE standard EN 60934 (IEC 60934).

Typical applications

Motors, transformers, solenoids, extra low voltage systems, household and office machines, instrumentation, marine applications, mobile homes.

Ordering information

Type No.	
1110	snap in panel mounting
Mounting	
F1	panel thickness 0.8...1.6 mm (.031 -.063 in)
F2	panel thickness 1.8...3 mm (.071-.118 in)
Number of poles	
1	1-pole protected
Actuator style	
2	black push button/white indicator ring, standard push-push function
B	black push button/white indicator ring, standard push-to-reset function
Other indicator ring colours are available to special order	
Terminal design	
P1	blade terminals A6.3-0.8 (QC .250)
Characteristic curve	
M1	medium delay
Current ratings	
0.05...16A	
1110 - F1 1 2 - P1 M1 - 0.05 A = ordering example	

Standard current ratings and typical internal resistance values

Current rating (A)	Internal resistance (Ω)	Current rating (A)	Internal resistance (Ω)
0.05	442	2	0.25
0.08	173	2.5	0.19
0.1	110	3	0.12
0.2	27.8	3.5	0.09
0.3	12.4	4	0.07
0.4	7.0	5	0.05
0.5	4.5	6	0.04
0.6	3.1	7	≤ 0.02
0.7	2.3	8	≤ 0.02
0.8	1.7	10	≤ 0.02
1	1.1	12	≤ 0.02
1.2	0.71	15	≤ 0.02
1.5	0.41	16	≤ 0.02
1.8	0.38		



1110-F1..

Technical data

For further details please see chapter: Technical Information

Voltage rating	AC 250 V; DC 28 V (UL: AC 250 V; DC 50 V)		
Current rating	0.05...16 A		
Typical life for S-type	AC + DC		
	0.05...10 A	10,000 operations at 1 x I _N , inductive	
	12...16 A	6,000 operations at 1 x I _N , inductive	
	for actuator style B:		
	0.05...10 A	200 operations at 2 x I _N , inductive	
Ambient temperature	-20...+60 °C (-4...+140 °F)		
Insulation co-ordination (IEC 60664 and 60664 A)	rated impulse withstand voltage	pollution degree	
	2.5 kV	2	
	reinforced insulation in operating area		
Dielectric strength (IEC 60664 and 60664A)	test voltage	operating area	
	AC 3,000 V		
Insulation resistance	> 100 MΩ (DC 500 V)		
Interrupting capacity I _{cn}	AC 250 V:	0.05...16 A	8 x I _N
	DC 28 V:	0.05...6 A	10 x I _N
		7...10 A	200 A
		12...16 A	300 A
Interrupting capacity (UL 1077/EN60934 PC 1)	I _N	U _N	
	0.05...6 A	AC 250 V	1,000 A
	7...16 A	AC 125 V	1,000 A
	0.05...16 A	DC 50 V	1,000 A
Degree of protection (IEC 60529/DIN 40050)	operating area IP40 terminal area IP00		
Vibration	8 g (57-500 Hz) ± 0.61 mm (10-57 Hz), to IEC 60068-2-6, test Fc, 10 frequency cycles/axis		
Shock	30 g (11 ms) to IEC 60068-2-27, test Ea		
Corrosion	96 hours at 5 % salt mist, to IEC 60068-2-11, test Ka		
Humidity	240 hours at 95 % RH to IEC 60068-2-78, test Cab		
Mass	approx. 12 g		

Approvals

Authority	Voltage ratings	Current ratings
for S-type:		
UL	AC 250 V AC 125 V DC 50 V	0.05...6 A 7...16 A 0.05...16 A
CSA	AC 250 V; DC 50 V	0.05...16 A
VDE	AC 250 V; DC 28 V	0.05...10 A

1

Dimensions

1110-F1.. / -F2..

When installing the circuit breaker apply pressure on bezel only.

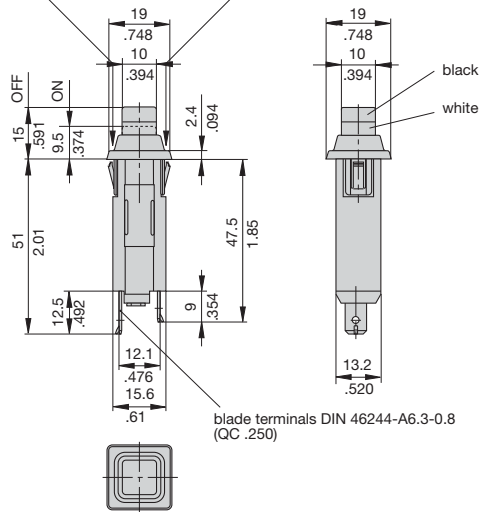

Panel cut out

1110-F1..-PM1...A

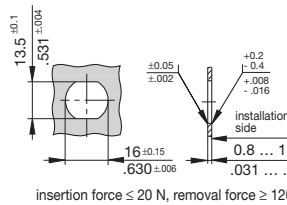

1110-F2..-PM1...A

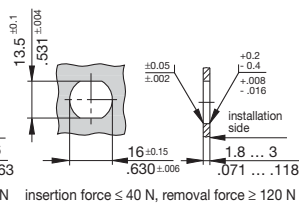

Installation drawing

When installing the circuit breaker apply pressure on bezel only.

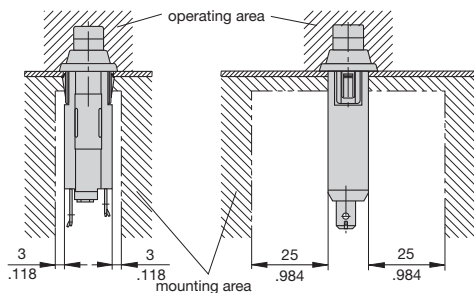

Internal connection diagram

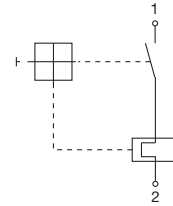

Typical time/current characteristics at +23 °C/+73.4 °F

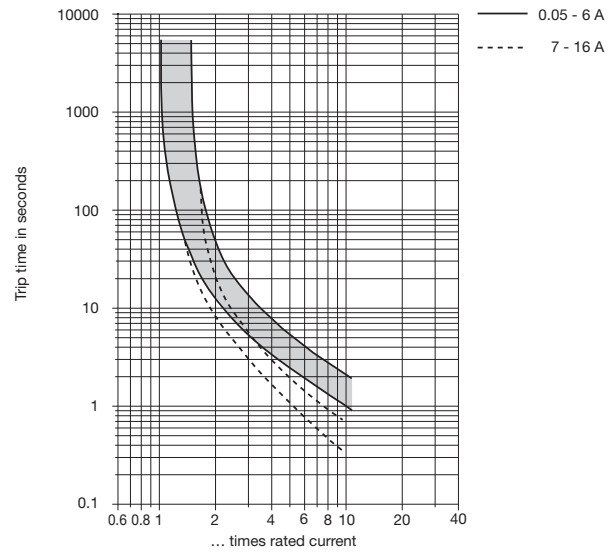

The time/current characteristic curve depends on the ambient temperature prevailing. In order to eliminate nuisance tripping, please multiply the circuit breaker current ratings by the derating factor shown below. See also section 9 – Technical information.

Ambient temperature °F	-4	+14	+32	+73.4	+104	+122	+140
°C	-20	-10	0	+23	+40	+50	+60
Derating factors	0.76	0.84	0.92	1	1.08	1.16	1.24

Accessories - Water splash covers (transparent)

Push button splash cover transparent Y 304 745 01 (IP64)

When using splash cover please note that the max. panel thickness is reduced by 0.5 mm/0.02 in.

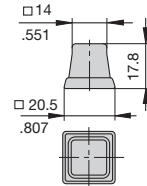

Terminal shroud Y 305 602 01 (IP64)

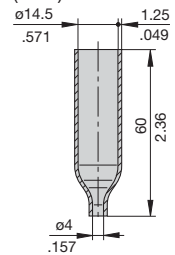

This is a metric design and millimeter dimensions take precedence ($\frac{mm}{inch}$)

All dimensions without tolerances are for reference only. In the interest of improved design, performance and cost effectiveness the right to make changes in these specifications without notice is reserved. Product markings may not be exactly as the ordering codes. Errors and omissions excepted.