

TYPE EDL Electric Double Layer Supercapacitors

Ultra High Capacitance, Small Case Size Options

RoHS Compliant



Type EDL electric double layer supercapacitors offer extremely high capacitance values (farads) in a variety of packaging options that will satisfy, low profile, surface mount, through hole and high density assembly requirements. The EDL is a cut above the standard electrolytic capacitor in that it can act as a battery without having to deal with the environmental or hazardous material issues that batteries entail.

Highlights

- Unlimited charging and discharging capability
- Recycling is not necessary
- Long Life - 15 years
- Low ESR
- Will extend battery life up to 1.6 times
- First class performance with economy pricing

Specifications

- Capacitance Range:** 0.22 F to 70 F
- Voltage Range:** 2.1 Vdc to 5.5 Vdc
- Temperature Range:** -25 °C to +85 °C
- Case Types:** Radial Leaded, Stacked Coin, SMT

Applications

- Telecom - cellular handsets
- Solar battery back-up
- Small motor starter
- Gaming machines
- Real time clock - battery
- Remote reading utility meters

Electric Double Layer Supercapacitor Construction

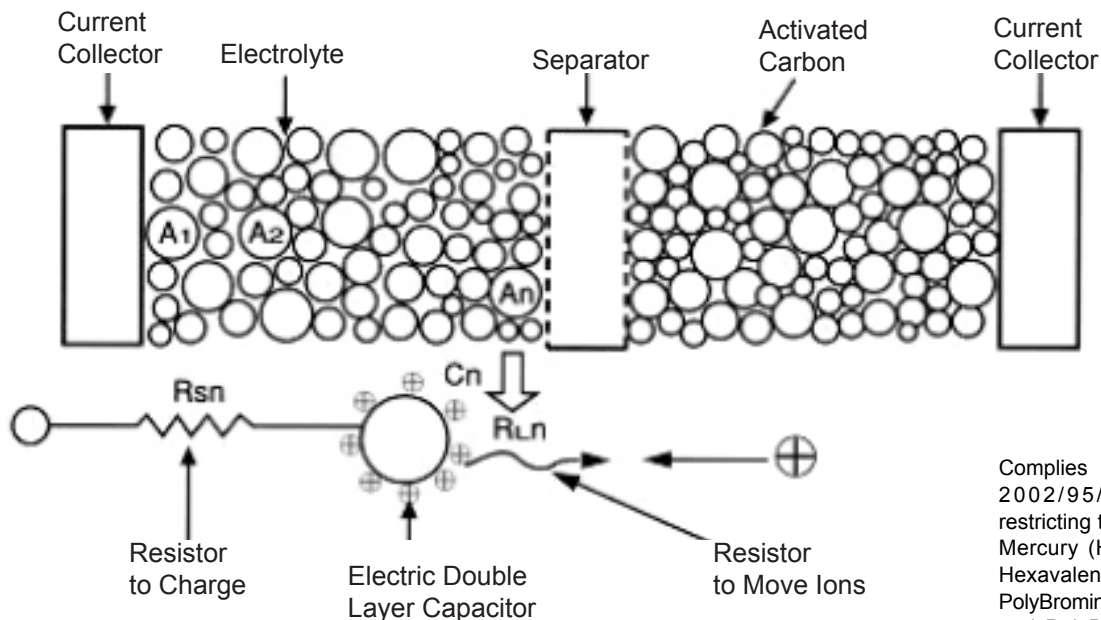





Complies with the restrictive 2002/95/EC requirement restricting the use of Lead (Pb), Mercury (Hg), Cadmium (Cd), Hexavalent chromium (Cr(VI)), PolyBrominated Biphenyls (PBB) and PolyBrominated Diphenyl Ethers (PBDE).

Type EDL Electric Double Layer Supercapacitors

Ratings

RoHS Compliant

Catalog Part Number	Capacitance	Voltage (Vdc)	Max. Resistance @ 1 kHz (Ω)	Case Type	Case Dia. (mm)	Case Length (mm)	Style
EDLHW335D2R3R	3.3 F	2.3	0.3	Radial Lead	12.5	23	HW 
EDLHW475D2R3R	4.7 F		0.3		12.5	23	
EDLHW106D2R3R	10 F		0.2		12.5	35	
EDLHW226D2R3R	22 F		0.1		18	35	
EDLHW306D2R3R	30 F		0.1		18	35	
EDLHW506D2R3R	50 F		0.1		18	40	
EDLHW706D2R1R	70 F	2.1	0.1		18	50	
EDLF473A5R5C	0.047 F	5.5	120	Stacked Coin	13.5	9.5	F  85 °C
EDLF104A5R5C	0.10 F		100		13.5	9.5	
EDLF474B5R5C	0.47 F		75		21.5	9.5	
EDLF684B5R5C	0.68 F		50		21.5	9.5	
EDLF105B5R5C	1.00 F		50		21.5	9.5	
EDLNF104A5R5C	.10 F	5.5	75	Stacked Coin	13.5	7.5	NF  70 °C
EDLNF224A5R5C	.22 F		75		13.5	7.5	
EDLNF474B5R5C	.47 F		30		21.5	8.0	
EDLNF105B5R5C	1.0 F		30		21.5	8.0	
EDLNF155B5R5C	1.5 F		30		21.5	8.0	
EDLSG474V5R5C	.47 F	5.5	30	Stacked Coin	19	5.0	SG 
EDLSG105V5R5C	1.0 F		30		19	5.0	
EDLSG155V5R5C	1.5 F		30		19	5.0	
EDLSG474H5R5C	.47 F	5.5	30	Stacked Coin	20	6.0	70 °C
EDLSG105H5R5C	1.0 F		30		20	6.0	
EDLSG155H5R5C	1.5 F		30		20	6.0	
EDLSD223V5R5C	.022 F	5.5	150	Stacked Coin	10.5	5.0	SD 
EDLSD473V5R5C	.047 F		120		10.5	5.0	
EDLSD104V5R5C	.10 F		75		10.5	5.0	
EDLSD224V5R5C	.22 F		75		10.5	5.0	
EDLSD334V5R5C	.33 F		75		10.5	5.0	
EDLSD223H5R5C	.022 F	5.5	150	Stacked Coin	11.5	5.5	70 °C
EDLSD473H5R5C	.047 F		120		11.5	5.5	
EDLSD104H5R5C	.10 F		75		11.5	5.5	
EDLSD224H5R5C	.22 F		75		11.5	5.5	
EDLSD334H5R5C	.33 F		75		11.5	5.5	
EDLEN204A3R3S	.20 F	3.3	200	SMT Wide Lead	6.8	1.8	EN 
EDLEN204B3R3S	.20 F	3.3	200	SMT Narrow Lead	6.8	1.8	
EDLEN204RL3R3S	.20 F	3.3	200	SMT Radial Lead	6.8	1.8	

TYPE EDL Electric Double Layer Supercapacitors

Outline Drawings

Style HW 70° C Radial Lead

Dimensions in mm (not to scale)

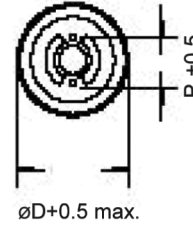
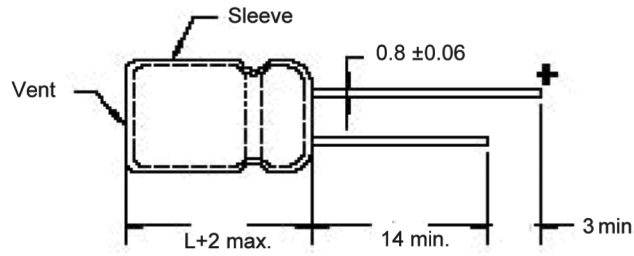

D	P
12.5	5
18	7.5

Style F 85° C Stacked Coin

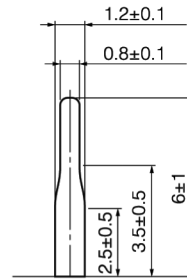
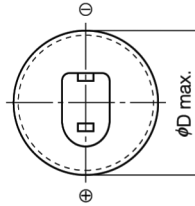
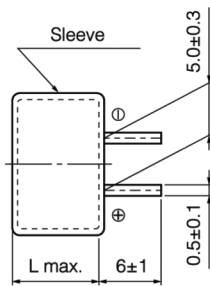

Case code	Size	
	D	L
A	13.5	9.5
B	21.5	9.5

Style NF 70° C Stacked Coin

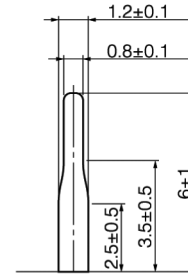
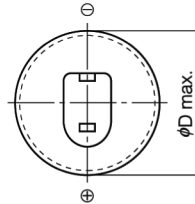
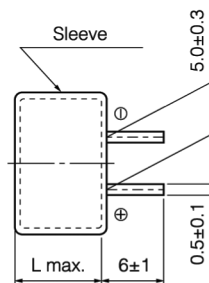

Case code	Size	
	D	L
A	13.5	7.5
B	21.5	8.0

Style SG 70° C Stacked Coin



Terminal V

Terminal H

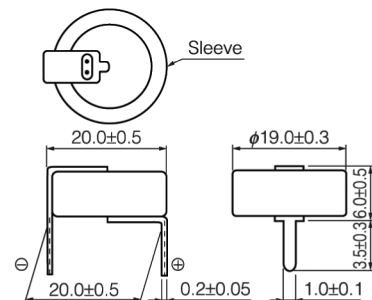
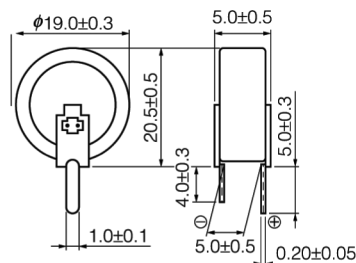

Type EDL Electric Double Layer Supercapacitors

Outline Drawings

Style SD 70° C Stacked Coin

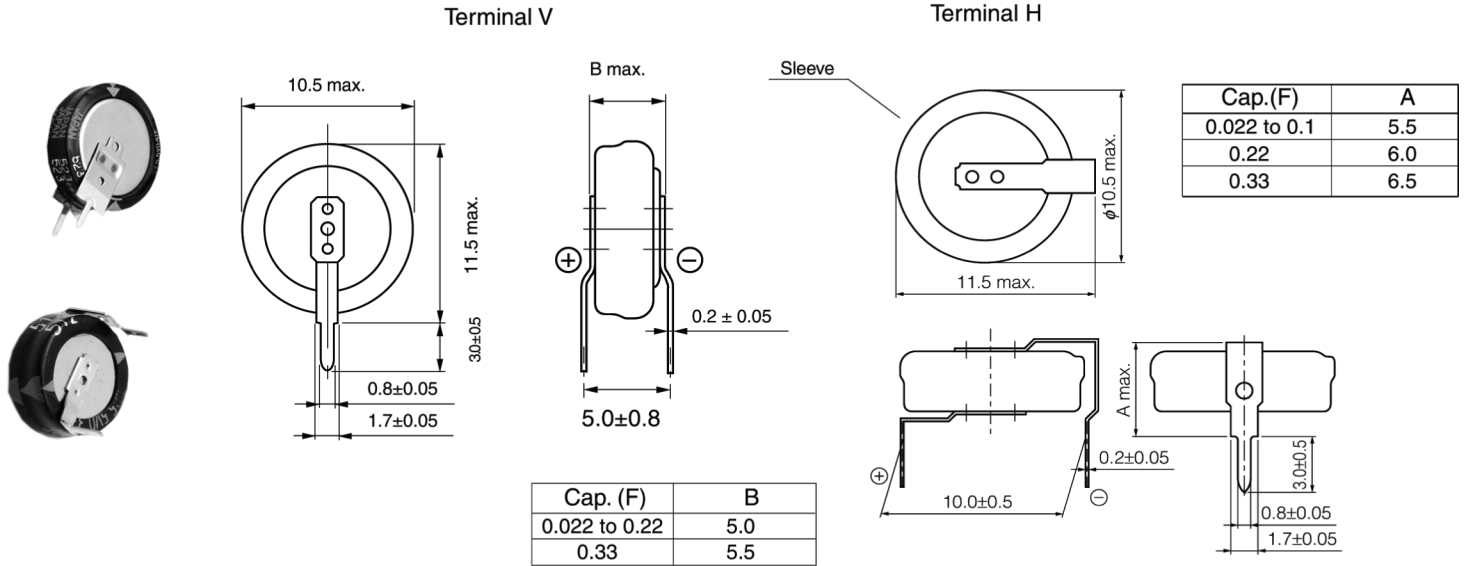

Style EN 60 °C Surface Mount

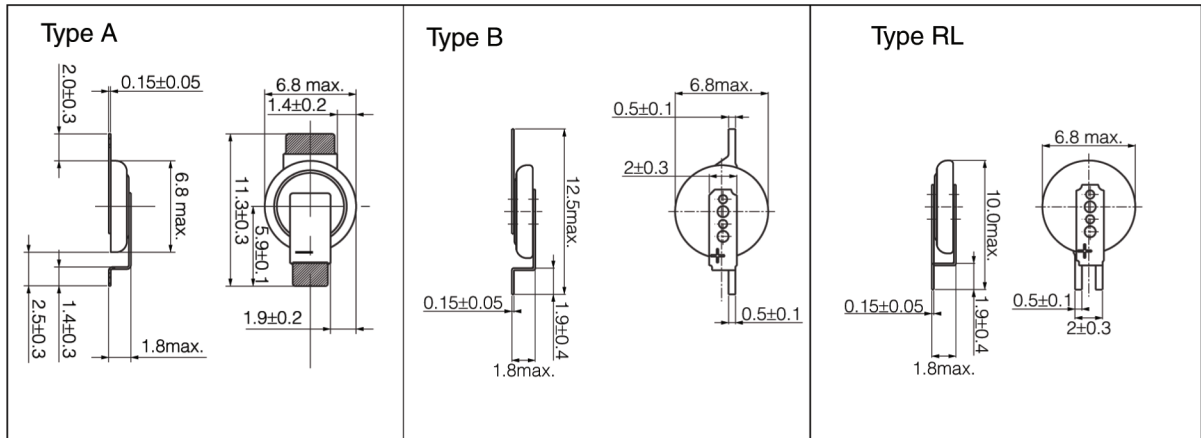

TYPE EDL Electric Double Layer Supercapacitors

Applications and Recommended Series

Application	Function	Recommended Series	Component
Mobile Phones	Real-Time Clock Back-Up	EN	
PDA	Real-Time Clock Back-Up		
DSC	Real-Time Clock Back-Up	EN, SD	
DVD Recorder	Real-Time Clock and Channel Back-Up	SD, SG	
Digital TV	Real-Time Clock and Channel Back-Up	SD, SG NF	
PC, Server	Real-Time Clock and Channel Back-Up	F	
Mobile Phone Base Station	Real-Time Clock and Channel Back-Up		
Inkjet Printer	Time and Impact Back-Up	SD, SG, NF	
Electric Power Gas and Water Meters	Real-Time Clock and Data Back-Up	F	
LED Light with Solar Battery	LED Lighting at Night	HW	
Toys	Motor Drives		
Toy Games	Real-Time Clock Back-Up	EN	
Robot	Real-Time Clock and Data Back-Up	F	
Car Audio Memory	Real-Time Clock Back-Up		

Type EDL Electric Double Layer Supercapacitors

How to Select an Electric Double Layer Supercapacitor

Estimated initial back-up time

Back-up time for Type EDL Electric Double Layer Supercapacitors decreases with use and over time especially when the current is large or operating at high temperature. Be sure to specify extra back-up time initially to allow for product changes.

Select the optimum supercapacitor according to applied current.

The internal resistance of the supercapacitor prevents drawing high discharge currents. Select the supercapacitor capable of delivering the peak current at switchover to back-up mode using the following table.

Series	Maximum Operating (Discharge) Current				
	0.047 F	0.1 F to 0.33 F	0.47 F to 1.5 F	3.3 F to 4.7 F	10 F to 50 F
SG, SD, NF	200 μ A	300 μ A	1 mA	–	–
F	200 μ A	300 μ A	300 μ A	–	–
EN	–	10 μ A	–	–	–
HW	–	–	100 mA	300 mA	1 A

Back-up Time Example

Back-up time is the time it takes for the applied voltage to decay to the cut-off voltage set by the user after applying the application's maximum voltage at application maximum temperature.

Example: An F Type EDL, P/N EDLF105B5R5C (Rated at 5.5 V, 1.0 F) is charged to 5.0 Vdc. The circuit requirement is such that it must maintain a memory circuit with a current drain of 10 μ A in an ambient temperature of +40 °C. The memory RTC cut-off voltage is 2.0 Vdc.

Using minimum capacitance, calculate the back-up time as follows:

$$t = C\Delta V / I = C[V_0 - (i \cdot R) - V_1] / (i + i_L)$$

$$C = 1.0 \text{ F} - 20\% = 0.8 \text{ F}, R = 50 \Omega, V_0 = 5 \text{ V}, V_1 = 2 \text{ V}, i = 10 \mu\text{A}$$

Therefore,

$$t = 0.8 (5 - 0.0005 - 2) / (10 + 2) / 10^{-6} = 55 \text{ hours}$$

And thus the initial back-up time is 55 hours. After 1000 hours,

t: Back-up time (s)

C: Capacitance of Type EDL (F)

V_0 : Applied voltage (V)

V_1 : Cut-off voltage (V)

i: Current during back-up (A)

i_L : Leakage current (A)

R: Internal resistance (Ω) at 1 kHz

Life Design for Electric Double Layer Supercapacitors

Type EDL supercapacitors have a useful lifetime that decreases with increasing operating temperature, humidity, applied-voltage, current and backup-time requirements.

Expected lifetime is the product of four factors:

$$\text{Expected Life} = (\text{Lifetime}) \cdot (\text{Temperature Factor}) \cdot (\text{Voltage Factor}) \cdot (\text{Moisture Factor})$$

TYPE EDL Electric Double Layer Supercapacitors

Lifetime

The minimum rated life at 85 °C with 5.5 Vdc applied is 1000 hours with maximum permitted end-of-life change of -30% capacitance and a 4 times increase in internal resistance.

Temperature Factor

To determine the effect of temperature on expected life of a supercapacitor, use the fact that expected lifetime doubles for each 10 °C that the operating temperature is reduced. As an illustration, at 85 °C and full voltage the rated lifetime is 1000 hours. So, at 40 °C the expected lifetime would be multiplied by $2^{(85-40)/10} = 2^{4.5} = 22.6$ times. The Temperature Factor is 22.6, and for 1000-h, 85 °C rated life, the expected 40 °C life would be 22600 hours.

Voltage Factor

The rate of change of capacitance decreases with decreasing applied voltage. The effect on life extension is roughly proportional to the voltage derating, e.g., 5 V applied to 5.5 V rated supercapacitors extends the life 1.1 times.

Moisture Factor

Expected life of these supercapacitors is considerably shortened by operation in high humidity. The applications discussed here assume that the relative humidity is no more than 50%.

Expected Life Example

So, for a 5.5 V supercapacitor at 40 °C charged to 5.V in less than 50% RH the expected life is

$$\begin{aligned}\text{Expected Life} &= (\text{Lifetime}) (\text{Temperature Factor}) (\text{Voltage Factor}) (\text{Moisture Factor}) \\ &= (1000 \text{ h}) (22.6) (1.1) (1) \\ &= 24800 \text{ hours} \\ &= 2.8 \text{ years}\end{aligned}$$

Type EDL Electric Double Layer Supercapacitors

Performance Data

Self-Discharging Characteristics Versus Charging Time

Part number EDLF105B5R5C (5.5 V 1.0 F) Charge voltage: 5 V

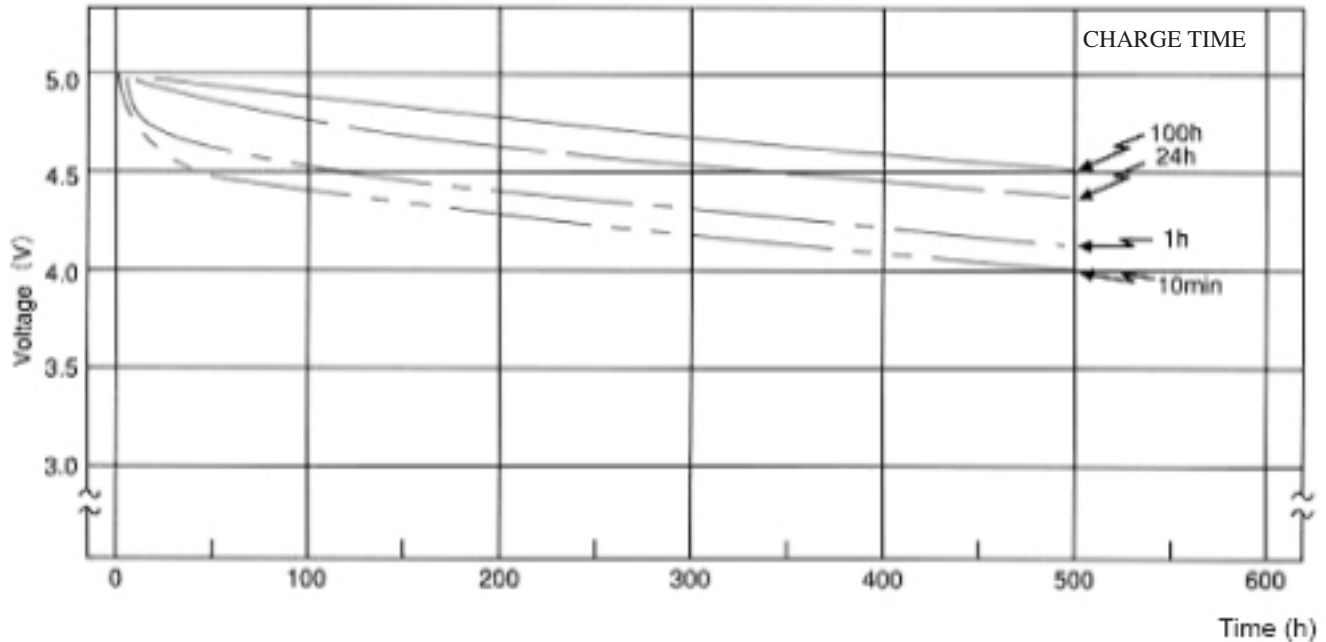

Charging Characteristics

Part number EDLF105B5R5C (5.5 V 1.0 F) @ +20 °C

