

Metallized Polypropylene Film Capacitors DC Capacitor MKP Type

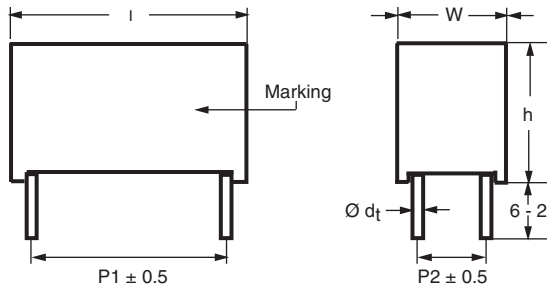
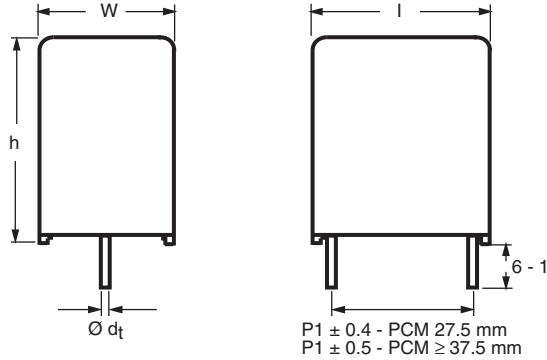

Dimensions in millimeters
 $\varnothing d_t \pm 10\%$ of standard diameter specified

APPLICATIONS

High performance DC filtering applications

REFERENCE STANDARDS

IEC 61071
 IEC 60068

MARKING

C-value; tolerance; rated voltage; code for dielectric material; code for manufacturing origin; manufacturer's type designation; manufacturer's logo; year and week of manufacture

DIELECTRIC

Polypropylene film

ELECTRODES

Metallized dielectric capacitor

CONSTRUCTION

Mono construction

ENCAPSULATION

Plastic case, sealed with resin
 Flame retardant

TERMINALS

Tinned wires

FEATURES

- Compliant to RoHS Directive 2002/95/EC

RATED CAPACITANCE

1 μ F to 400 μ F

CAPACITANCE TOLERANCE

$\pm 5\%$

DC VOLTAGE RATING

U_{NDC} at 85 °C	450 V	700 V	900 V	1100 V	1200 V
U_{OPDC} at 70 °C	500 V	800 V	1100 V	1350 V	1500 V
U_{OPDC} at 105 °C	300 V	500 V	650 V	800 V	850 V

INSULATION RESISTANCE

RC between leads, after 1 min > 10 000 s
 For $U_{NDC} \leq 500$ V measuring voltage 100 V
 For $U_{NDC} > 500$ V measuring voltage 500 V

SELF INDUCTANCE (L_s)

< 1 nH per mm of lead spacing

WITHSTANDING DC VOLTAGE BETWEEN TERMINALS

1.5 U_{NDC} for 10 s, cut off current 10 mA, rise time ≤ 1000 V/s
 See document "Voltage test for metallized capacitors"

www.vishay.com/doc?28169

MAXIMUM APPLICABLE PEAK TO PEAK RIPPLE VOLTAGE

0.2 x U_{NDC}

CLIMATIC TESTING CLASS

40/105/56

RATED TEMPERATURE

85 °C

MAXIMUM PERMISSIBLE CASE TEMPERATURE

105 °C, observing voltage derating

LIFE TIME EXPECTANCY

Useful life time: > 100 000 h at U_{NDC} and 85 °C
 FIT: < 10 x 10⁻⁹/h (10 per 10⁹ component h) at 0.5 x U_{NDC} ; 40 °C

DETAIL SPECIFICATION

For more detailed data and test requirements, contact:
dc-film@vishay.com

GENERAL INFORMATION

Characteristics and definitions used for film capacitors:
www.vishay.com/docs/28147/intro.pdf



RoHS
 COMPLIANT

MKP 1848 DC-Link

Vishay Roederstein

Metallized Polypropylene Film Capacitors
DC Capacitor MKP Type



COMPOSITION OF CATALOG NUMBER

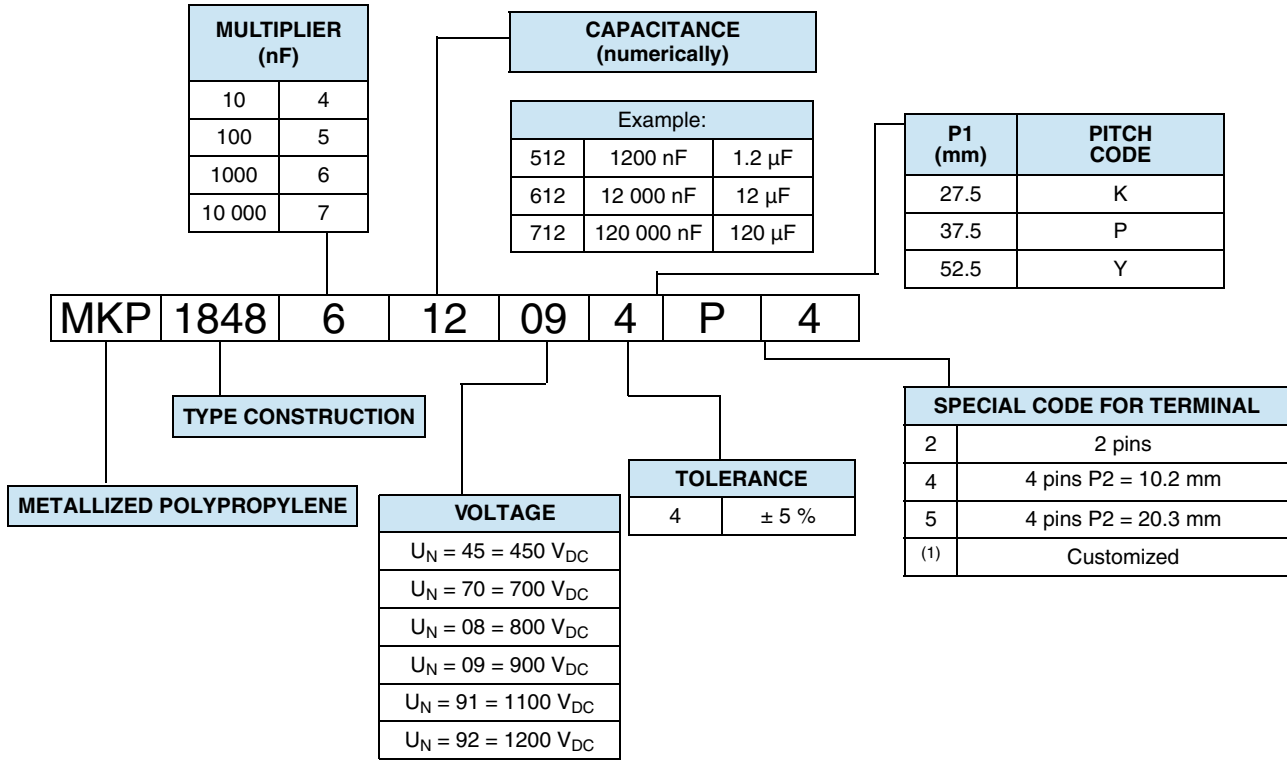

Note

(1) Tabs terminals or customized terminals are available on request

MULTIPLE PINS CAPACITORS

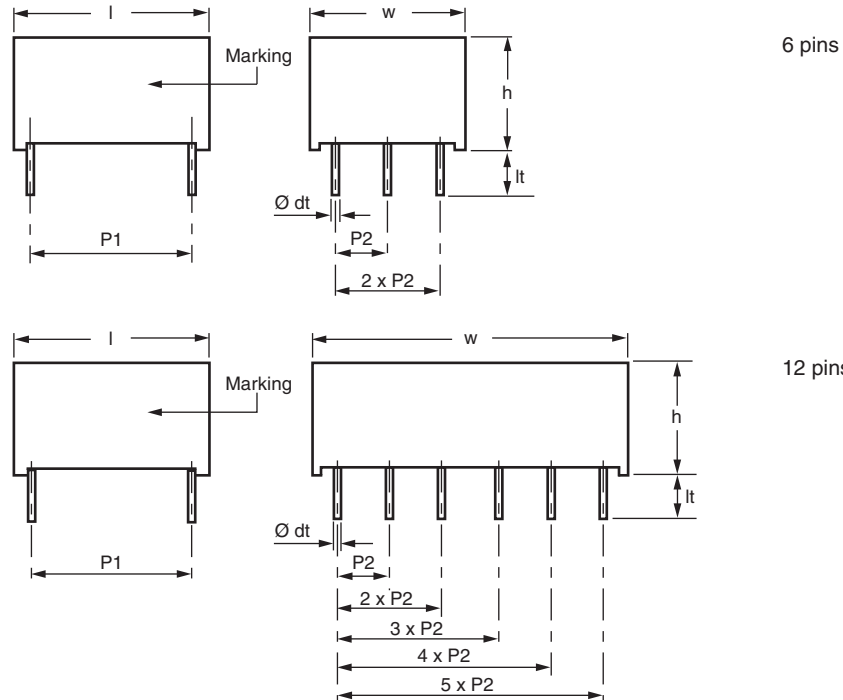



Metallized Polypropylene Film Capacitors
DC Capacitor MKP Type

Vishay Roederstein

SPECIFIC REFERENCE DATA 450 V_{DC}

U_{NDC} at 85 °C = 450 V, U_{OPDC} at 70 °C = 500 V, U_{OPDC} at 105 °C = 300 V

CAP. (9)	DIMENSIONS (mm) (5)			P1 (mm)	P2 (mm)	Ø dt (mm)	dV/dt (V/µs)	I _{PEAK} (A)	I _{RMS} (A) (2)		ESR (mΩ) (3)		tan δ 1 kHz < (10 ⁻⁴) (4)		tan δ 10 kHz < (10 ⁻⁴) (4)		MASS (g)	SPQ (6) (pcs)	PART NUMBER (1)
	(µF)	w	h						l	2 pins	4 pins	2 pins	4 pins	2 pins	4 pins	2 pins			
1	9.0	19.0	32.0	27.5	-	0.8	75	75	2.5	-	54	-	10	-	85	-	6.0	160	MKP1848510454K2
2	9.0	19.0	32.0	27.5	-	0.8	75	150	3	-	34.5	-	10	-	85	-	5.5	160	MKP1848520454K2
3	11.0	21.0	32.0	27.5	-	0.8	75	225	4	-	23.0	-	10	-	85	-	8.5	130	MKP1848530454K2
4	11.0	21.0	32.0	27.5	-	0.8	75	300	4	-	20.5	-	10	-	85	-	8.5	130	MKP1848540454K2
5	13.0	23.0	32.0	27.5	-	0.8	75	375	5	-	16.5	-	10	-	85	-	10.5	115	MKP1848550454K2
6	15.0	25.0	32.0	27.5	-	0.8	75	450	6	-	13.5	-	10	-	85	-	12.5	100	MKP1848560454K2
7	15.0	25.0	32.0	27.5	-	0.8	75	525	6.5	-	11.5	-	10	-	85	-	11.5	100	MKP1848570454K2
8	18.0	28.0	32.0	27.5	-	0.8	75	600	8.5	-	8.5	-	10	-	85	-	15.0	80	MKP1848580454K2
9	18.0	28.0	32.0	27.5	-	0.8	75	675	8.5	-	9.0	-	10	-	85	-	16.0	80	MKP1848590454K2
10	18.0	28.0	32.0	27.5	-	0.8	75	750	9	-	8.0	-	10	-	85	-	15.0	80	MKP1848610454K2
12	21.0	31.0	32.0	27.5	-	0.8	75	900	10	-	7.0	-	10	-	85	-	21.5	65	MKP1848612454K2
15	20.0	35.0	32.0	27.5	-	0.8	75	1125	11.5	-	6.0	-	10	-	85	-	20.0	70	MKP1848615454K2
10	18.5	35.5	43.0	37.5	10.2	1.0	40	400	7.5	8	13.5	12.0	18	16	160	140	34	105	MKP1848610454P*
12	18.5	35.5	43.0	37.5	10.2	1.0	40	480	8	8.5	11.5	10.0	18	16	160	140	32	105	MKP1848612454P*
15	18.5	35.5	43.0	37.5	10.2	1.0	40	600	9	10	9.0	8.0	18	16	160	140	30	105	MKP1848615454P*
20	21.5	38.5	43.0	37.5	10.2	1.0	40	800	11	12	7.0	6.0	18	16	160	140	36	91	MKP1848620454P*
22	21.5	38.5	43.0	37.5	10.2	1.0	40	880	11	11.5	7.5	6.5	18	16	160	140	38	91	MKP1848622454P*
25	21.5	38.5	43.0	37.5	10.2	1.0	40	1000	11.5	12.5	6.5	5.5	18	16	160	140	36	91	MKP1848625454P*
30	24.0	44.0	42.0	37.5	10.2	1.0	40	1200	13.5	15	5.5	4.5	18	16	160	140	48	77	MKP1848630454P*
35	30.0	45.0	42.0	37.5	10.2/20.3	1.0	40	1400	17	18.5	4.0	3.5	18	16	160	140	57	63	MKP1848635454P*
40	30.0	45.0	42.0	37.5	10.2/20.3	1.0	40	1600	17	18.5	4.0	3.5	18	16	160	140	60	63	MKP1848640454P*
40	25.0	45.0	57.5	52.5	10.2	1.2	20	800	13	13.5	6.5	6.0	35	30	310	280	66	55	MKP1848640454Y*
45	25.0	45.0	57.5	52.5	10.2	1.2	20	900	12.5	13.5	7.0	6.0	35	30	310	280	70	55	MKP1848645454Y*
50	30.0	45.0	57.5	52.5	20.3	1.2	20	1000	15	15.5	5.5	5.0	35	30	310	280	88	45	MKP1848650454Y*
55	30.0	45.0	57.5	52.5	20.3	1.2	20	1100	15	15.5	5.5	5.0	35	30	310	280	96	45	MKP1848655454Y*
60	30.0	45.0	57.5	52.5	20.3	1.2	20	1200	15.5	16.5	5.0	4.5	35	30	310	280	91	45	MKP1848660454Y*
65	35.0	50.0	57.5	52.5	20.3	1.2	20	1300	19	20.5	4.0	3.5	35	30	310	280	100	40	MKP1848665454Y*
70	35.0	50.0	57.5	52.5	20.3	1.2	20	1400	18	19	4.5	4.0	35	30	310	280	112	40	MKP1848670454Y*
75	35.0	50.0	57.5	52.5	20.3	1.2	20	1500	19	20.5	4.0	3.5	35	30	310	280	108	40	MKP1848675454Y*
80	35.0	50.0	57.5	52.5	20.3	1.2	20	1600	19	20.5	4.0	3.5	35	30	310	280	102	40	MKP1848680454Y*
90	45.0	45.0	57.5	52.5	20.3	1.2	20	1800	-	21.5	-	3.0	-	30	-	280	127	30	MKP1848690454Y5
95	45.0	45.0	57.5	52.5	20.3	1.2	20	1900	-	21.5	-	3.0	-	30	-	280	124	30	MKP1848695454Y5
100	45.0	45.0	57.5	52.5	20.3	1.2	20	2000	-	23.5	-	2.5	-	30	-	280	120	30	MKP1848710454Y5
200 (10)	70.0	60.0	57.5	52.5	20.3	1.2	20	2000	-	30.5	-	2.0	-	35	-	310	266	20	MKP1848720454Y5 (7)
400 (10)	130	60.0	57.5	52.5	20.3	1.2	10	4000	-	50.5	-	1.5	-	35	-	380	490	10	MKP1848740454Y5 (8)

Notes

- (1) Change the * symbol with special code for the terminals
- (2) Maximum RMS current at 10 kHz, + 85 °C, Δt = + 15 °C, Cap. tol. ≤ ± 5 %
- (3) Equivalent series resistance typical values at 10 kHz
- (4) Maximum tan δ values
- (5) Standard dimension
- (6) SPQ = Standard Packing Quantity
- (7) 6 pins
- (8) 12 pins
- (9) Intermediate capacitance values available on request.
- (10) Under release

MKP 1848 DC-Link



Vishay Roederstein Metallized Polypropylene Film Capacitors
DC Capacitor MKP Type

SPECIFIC REFERENCE DATA 700 V_{DC}

U_{NDC} at 85 °C = 700 V, U_{OPDC} at 70 °C = 800 V, U_{OPDC} at 105 °C = 500 V

CAP. (⁹)	DIMENSIONS (mm) (⁵)			P1	P2	Ø dt	dV/dt	I _{PEAK}	I _{RMS} (A) (²)		ESR (mΩ) (³)		tan δ 1 kHz < (10 ⁻⁴) (⁴)		tan δ 10 kHz < (10 ⁻⁴) (⁴)		MASS (g)	SPQ (⁵)	PART NUMBER (¹)
	(µF)	w	h						l	(mm)	(mm)	(mm)	(V/µs)	(A)	2 pins	4 pins			
1	9.0	19.0	32.0	27.5	-	0.8	75	75	2.5	-	54.0	-	8.0	-	68	-	6.0	160	MKP1848510704K2
2	9.0	19.0	32.0	27.5	-	0.8	75	150	3	-	34.5	-	8.0	-	68	-	5.5	160	MKP1848520704K2
3	11.0	21.0	32.0	27.5	-	0.8	75	225	4	-	23.0	-	8.0	-	68	-	8.5	130	MKP1848530704K2
4	13.0	23.0	32.0	27.5	-	0.8	75	300	5	-	17.0	-	8.0	-	68	-	10.5	115	MKP1848540704K2
5	15.0	25.0	32.0	27.5	-	0.8	75	375	6	-	14.0	-	8.0	-	68	-	12	100	MKP1848550704K2
6	18.0	28.0	32.0	27.5	-	0.8	75	450	7.5	-	11.5	-	8.0	-	68	-	17	80	MKP1848560704K2
7	18.0	28.0	32.0	27.5	-	0.8	75	525	8	-	10.0	-	8.0	-	68	-	16	80	MKP1848570704K2
8	18.0	28.0	32.0	27.5	-	0.8	75	600	8.5	-	8.5	-	8.0	-	68	-	15	80	MKP1848580704K2
9	21.0	31.0	32.0	27.5	-	0.8	75	675	10	-	7.5	-	8.0	-	68	-	22	65	MKP1848590704K2
10	21.0	31.0	32.0	27.5	-	0.8	75	750	10	-	7.0	-	8.0	-	68	-	21	65	MKP1848610704K2
12	20.0	35.0	32.0	27.5	-	0.8	75	900	11.5	-	6.0	-	8.0	-	68	-	20	70	MKP1848612704K2
10	18.5	35.5	43.0	37.5	10.2	1.0	40	400	7.5	8	13.5	12.0	15	13	135	120	34	105	MKP1848610704P*
12	18.5	35.5	43.0	37.5	10.2	1.0	40	480	8	8.5	11.5	10.0	15	13	135	120	32	105	MKP1848612704P*
15	18.5	35.5	43.0	37.5	10.2	1.0	40	600	9	10	9.0	8.0	15	13	135	120	30	105	MKP1848615704P*
20	21.5	38.5	43.0	37.5	10.2	1.0	40	800	11	12	7.0	6.0	15	13	135	120	36	91	MKP1848620704P*
22	24.0	44.0	42.0	37.5	10.2	1.0	40	880	13	13.5	6.0	5.5	15	13	135	120	49	77	MKP1848622704P*
25	24.0	44.0	42.0	37.5	10.2	1.0	40	1000	13.5	14.5	5.5	5.0	15	13	135	120	47	77	MKP1848625704P*
30	30.0	45.0	42.0	37.5	10.2/20.3	1.0	40	1200	16	17	4.5	4.0	15	13	135	120	62	63	MKP1848630704P*
35	30.0	45.0	42.0	37.5	10.2/20.3	1.0	40	1400	17	18.5	4.0	3.5	15	13	135	120	55	63	MKP1848635704P*
30	25.0	45.0	57.5	52.5	10.2	1.2	20	600	11	12	9.0	8.0	30	25	270	240	76	55	MKP1848630704Y*
35	25.0	45.0	57.5	52.5	10.2	1.2	20	700	12	12.5	7.5	7.0	30	25	270	240	71	55	MKP1848635704Y*
40	25.0	45.0	57.5	52.5	10.2	1.2	20	800	13	13.5	6.5	6.0	30	25	270	240	66	55	MKP1848640704Y*
45	30.0	45.0	57.5	52.5	20.3	1.2	20	900	14.5	15	6.0	5.5	30	25	270	240	95	45	MKP1848645704Y*
50	30.0	45.0	57.5	52.5	20.3	1.2	20	1000	15	15.5	5.5	5.0	30	25	270	240	88	45	MKP1848650704Y*
55	35.0	50.0	57.5	52.5	20.3	1.2	20	1100	17	18	5.0	4.5	30	25	270	240	112	40	MKP1848655704Y*
60	35.0	50.0	57.5	52.5	20.3	1.2	20	1200	18	19	4.5	4.0	30	25	270	240	107	40	MKP1848660704Y*
65	35.0	50.0	57.5	52.5	20.3	1.2	20	1300	19	20.5	4.0	3.5	30	25	270	240	100	40	MKP1848665704Y*
70	45.0	45.0	57.5	52.5	20.3	1.2	20	1400	-	20	-	3.5	-	25	-	240	128	30	MKP1848670704Y5
75	45.0	45.0	57.5	52.5	20.3	1.2	20	1500	-	21.5	-	3.0	-	25	-	240	123	30	MKP1848675704Y5
80	45.0	45.0	57.5	52.5	20.3	1.2	20	1600	-	21.5	-	3.0	-	25	-	240	119	30	MKP1848680704Y5
160 (¹⁰)	70.0	65.0	57.5	52.5	20.3	1.2	20	3200	-	30.5	-	2.5	-	28	-	280	264	20	MKP1848716704Y5 (⁷)
320 (¹⁰)	130.0	65.0	57.5	52.5	20.3	1.2	20	6400	-	54	-	1.3	-	28	-	280	359	10	MKP1848732704Y5 (⁸)

Notes

- (1) Change the * symbol with special code for the terminals
- (2) Maximum RMS current at 10 kHz, + 85 °C, Δt = + 15 °C, Cap. tol. ≤ ± 5 %
- (3) Equivalent series resistance typical values at 10 kHz
- (4) Maximum tan δ values
- (5) Standard dimension
- (6) SPQ = Standard Packing Quantity
- (7) 6 pins
- (8) 12 pins
- (9) Intermediate capacitance values available on request.
- (10) Under release



SPECIFIC REFERENCE DATA 800V_{DC}

U_{NDC} at 85 °C = 800 V, U_{OPDC} at 70 °C = 900 V, U_{OPDC} at 105 °C = 570 V

CAP. (9)	DIMENSIONS (mm) (5)			P1	P2	Ø dt	dU/dt	I _{PEAK}	I _{RMS} (A) (2)		ESR (mΩ) (3)		tan δ 1 kHz < (10 ⁻⁴) (4)		tan δ 10 kHz < (10 ⁻⁴) (4)		MASS (g)	SPQ (5)	PART NUMBER (1)
	(µF)	w	h						l	(mm)	(mm)	(mm)	(V/µs)	(A)	2 pins	4 pins			
1	9.0	19.0	32.0	27.5	-	0.8	75	75	2	-	62.5	-	7.0	-	60	-	6.5	160	MKP1848510084K2
2	11.0	21.0	32.0	27.5	-	0.8	75	150	3.5	-	31.0	-	7.0	-	60	-	9.0	130	MKP1848520084K2
3	13.0	23.0	32.0	27.5	-	0.8	75	225	4.5	-	21.0	-	7.0	-	60	-	11	115	MKP1848530084K2
4	15.0	25.0	32.0	27.5	-	0.8	75	300	5.5	-	15.5	-	7.0	-	60	-	12	100	MKP1848540084K2
5	18.0	28.0	32.0	27.5	-	0.8	75	375	7	-	12.5	-	7.0	-	60	-	17	80	MKP1848550084K2
6	18.0	28.0	32.0	27.5	-	0.8	75	450	7.5	-	10.5	-	7.0	-	60	-	16	80	MKP1848560084K2
7	21.0	31.0	32.0	27.5	-	0.8	75	525	9	-	9.0	-	7.0	-	60	-	23	65	MKP1848570084K2
8	21.0	31.0	32.0	27.5	-	0.8	75	600	9.5	-	8.0	-	7.0	-	60	-	21	65	MKP1848580084K2
9	20.0	35.0	32.0	27.5	-	0.8	75	675	10	-	8.0	-	7.0	-	60	-	21	70	MKP1848590084K2
10	18.5	35.5	43.0	37.5	10.2	1.0	40	400	8	8.5	12.5	11.0	14	12	122	110	32	105	MKP1848610084P*
12	18.5	35.5	43.0	37.5	10.2	1.0	40	480	8.5	9	10.5	9.0	14	12	122	110	30	105	MKP1848612084P*
15	21.5	38.5	43.0	37.5	10.2	1.0	40	600	10	11	8.5	7.5	14	12	122	110	37	91	MKP1848615084P*
20	24.0	44.0	42.0	37.5	10.2	1.0	40	800	13	13.5	6.0	5.5	14	12	122	110	47	77	MKP1848620084P*
22	30.0	45.0	42.0	37.5	10.2/ 20.3	1.0	40	880	14.5	15.5	5.5	5.0	14	12	122	110	65	63	MKP1848622084P*
25	30.0	45.0	42.0	37.5	10.2/ 20.3	1.0	40	1000	15.5	16	5.0	4.5	14	12	122	110	61	63	MKP1848625084P*
30	25.0	45.0	57.5	52.5	10.2	1.2	10	300	12	12	8.0	7.5	25	22	240	215	69	55	MKP1848630084Y*
35	30.0	45.0	57.5	52.5	20.3	1.2	10	350	13	14.5	7.0	6.0	25	22	240	215	97	45	MKP1848635084Y*
40	30.0	45.0	57.5	52.5	20.3	1.2	10	400	14.5	15	6.0	5.5	25	22	240	215	91	45	MKP1848640084Y*
45	35.0	50.0	57.5	52.5	20.3	1.2	10	450	16	17	5.5	5.0	25	22	240	215	112	40	MKP1848645084Y*
50	35.0	50.0	57.5	52.5	20.3	1.2	10	500	17	18	5.0	4.5	25	22	240	215	104	40	MKP1848650084Y*
55	45.0	45.0	57.5	52.5	20.3	1.2	10	550	-	18.5	-	4.0	-	22	-	215	131	30	MKP1848655084Y5
60	45.0	45.0	57.5	52.5	20.3	1.2	10	600	-	20	-	3.5	-	22	-	215	125	30	MKP1848660084Y5
120 (10)	70.0	65.0	57.5	52.5	20.3	1.2	10	1600	-	27	-	3.2	-	22	-	215	276	20	MKP1848712084Y5 (7)
240 (10)	130.0	65.0	57.5	52.5	20.3	1.2	10	3200	-	48.5	-	1.6	-	22	-	215	393	10	MKP1848724084Y5 (8)

Notes

- (1) Change the * symbol with special code for the terminals
- (2) Maximum RMS current at 10 kHz, + 85 °C, Δt = + 15 °C, Cap. tol. ≤ ± 5 %
- (3) Equivalent series resistance typical values at 10 kHz
- (4) Maximum tan δ values
- (5) Standard dimension
- (6) SPQ = Standard Packing Quantity
- (7) 6 pins
- (8) 12 pins
- (9) Intermediate capacitance values available on request.
- (10) Under release

MKP 1848 DC-Link



Vishay Roederstein Metallized Polypropylene Film Capacitors
DC Capacitor MKP Type

SPECIFIC REFERENCE DATA 900V_{DC}

U_{NDC} at 85 °C = 900 V, U_{OPDC} at 70 °C = 1100 V, U_{OPDC} at 105 °C = 650 V

CAP. (9)	DIMENSIONS (mm) (5)			P1	P2	Ø dt	dV/dt	I _{PEAK}	I _{RMS} (A) (2)		ESR (mΩ) (3)		tan δ 1 kHz < (10 ⁻⁴) (4)		tan δ 10 kHz < (10 ⁻⁴) (4)		MASS (g)	SPQ (5)	PART NUMBER (1)
	(µF)	w	h						l	(mm)	(mm)	(V/µs)	(A)	2 pins	4 pins	2 pins			
1	9.0	19.0	32.0	27.5	-	0.8	40	40	2	-	63.0	-	7.0	-	50	-	6.0	160	MKP1848510094K2
2	13.0	23.0	32.0	27.5	-	0.8	80	160	3.5	-	32.0	-	7.0	-	50	-	11.0	115	MKP1848520094K2
3	15.0	25.0	32.0	27.5	-	0.8	80	240	5	-	21.0	-	7.0	-	50	-	12.0	100	MKP1848530094K2
4	18.0	28.0	32.0	27.5	-	0.8	80	320	6	-	16.0	-	7.0	-	50	-	16.5	80	MKP1848540094K2
5	21.0	31.0	32.0	27.5	-	0.8	80	400	7.5	-	13.0	-	7.0	-	50	-	22.5	65	MKP1848550094K2
6	21.0	31.0	32.0	27.5	-	0.8	80	480	8.5	-	10.0	-	7.0	-	50	-	21.0	65	MKP1848560094K2
7	20.0	35.0	32.0	27.5	-	0.8	80	560	9	-	9.0	-	7.0	-	50	-	21.0	70	MKP1848570094K2
5	18.5	35.5	43.0	37.5	10.2	1.0	20	100	6	6.5	21.0	19.0	12	10	100	90	32	105	MKP1848550094P*
6	18.5	35.5	43.0	37.5	10.2	1.0	40	240	6.5	7	18.0	16.0	12	10	100	90	30	105	MKP1848560094P*
7	18.5	35.5	43.0	37.5	10.2	1.0	40	280	6.5	7	18.0	16.0	12	10	100	90	33	105	MKP1848570094P*
8	18.5	35.5	43.0	37.5	10.2	1.0	40	320	7	7.5	16.0	14.0	12	10	100	90	31	105	MKP1848580094P*
9	18.5	35.5	43.0	37.5	10.2	1.0	40	360	7.5	8	14.0	12.0	12	10	100	90	30	105	MKP1848590094P*
10	21.5	38.5	43.0	37.5	10.2	1.0	40	400	8.5	9	12.0	11.0	12	10	100	90	39	91	MKP1848610094P*
12	21.5	38.5	43.0	37.5	10.2	1.0	40	480	9.5	10	10.0	9.0	12	10	100	90	36	91	MKP1848612094P*
15	24.0	44.0	42.0	37.5	10.2	1.0	40	600	11	12	8.0	7.0	12	10	100	90	47	77	MKP1848615094P*
16	24.0	44.0	42.0	37.5	10.2	1.0	40	640	11	12	8.0	7.0	12	10	100	90	45	77	MKP1848616094P*
20	30.0	45.0	42.0	37.5	10.2/ 20.3	1.0	40	800	14	15.5	6.0	5.0	12	10	100	90	57	63	MKP1848620094P*
15	25.0	45.0	57.5	52.5	10.2	1.2	20	300	9	9.5	14.0	12.0	25	20	200	185	70	55	MKP1848615094Y*
20	25.0	45.0	57.5	52.5	10.2	1.2	20	400	9.5	10	12.0	11.0	25	20	200	185	73	55	MKP1848620094Y*
22	25.0	45.0	57.5	52.5	10.2	1.2	20	440	10	10.5	11.0	10.0	25	20	200	185	70	55	MKP1848622094Y*
25	30.0	45.0	57.5	52.5	20.3	1.2	20	500	11	11.5	10.0	9.0	25	20	200	185	98	45	MKP1848625094Y*
30	30.0	45.0	57.5	52.5	20.3	1.2	20	600	12.5	13	8.0	7.0	25	20	200	185	89	45	MKP1848630094Y*
35	35.0	50.0	57.5	52.5	20.3	1.2	20	700	14.5	15.5	7.0	6.0	25	20	200	185	109	40	MKP1848635094Y*
40	35.0	50.0	57.5	52.5	20.3	1.2	20	800	15.5	17	6.0	5.0	25	20	200	185	99	40	MKP1848640094Y*
45	45.0	45.0	57.5	52.5	20.3	1.2	20	900	-	16.5	-	5.0	-	20	-	185	124	30	MKP1848645094Y5
50	45.0	45.0	57.5	52.5	20.3	1.2	20	1000	-	18.5	-	4.0	-	20	-	185	117	30	MKP1848650094Y5
100 (10)	70.0	65.0	57.5	52.5	20.3	1.2	20	2000	-	26.5	-	3.3	-	22	-	205	259	20	MKP1848710094Y5 (7)
200 (10)	130.0	65.0	57.5	52.5	20.3	1.2	20	4000	-	48.5	-	1.6	-	22	-	205	608	10	MKP1848720094Y5 (8)

Notes

- (1) Change the * symbol with special code for the terminals
- (2) Maximum RMS current at 10 kHz, + 85 °C, Δt = + 15 °C, Cap. tol. ≤ ± 5 %
- (3) Equivalent series resistance typical values at 10 kHz
- (4) Maximum tan δ values
- (5) Standard dimension
- (6) SPQ = Standard Packing Quantity
- (7) 6 pins
- (8) 12 pins
- (9) Intermediate capacitance values available on request.
- (10) Under release



SPECIFIC REFERENCE DATA 1100 V_{DC}

U_{NDC} at 85 °C = 1100 V, U_{OPDC} at 70 °C = 1350 V, U_{OPDC} at 105 °C = 800 V

CAP. (9)	DIMENSIONS (mm) (5)			P1	P2	Ø dt	dV/dt	I _{PEAK}	I _{RMS} (A) (2)		ESR (mΩ) (3)		tan δ 1 kHz < (10 ⁻⁴) (4)		tan δ 10 kHz < (10 ⁻⁴) (4)		MASS (g)	SPQ (5)	PART NUMBER (1)
	(µF)	w	h						l	(mm)	(mm)	(mm)	(V/µs)	(A)	2 pins	4 pins			
1	11.0	21.0	32.0	27.5	-	0.8	95	95	3	-	45.5	-	6.0	-	45	-	9.0	130	MKP1848510914K2
2	15.0	25.0	32.0	27.5	-	0.8	95	190	4.5	-	23.0	-	6.0	-	45	-	12.0	100	MKP1848520914K2
3	18.0	28.0	32.0	27.5	-	0.8	95	285	6	-	15.5	-	6.0	-	45	-	16.0	80	MKP1848530914K2
4	21.0	31.0	32.0	27.5	-	0.8	95	380	8	-	11.5	-	6.0	-	45	-	21.5	65	MKP1848540914K2
5	20.0	35.0	32.0	27.5	-	0.8	95	475	9	-	9.5	-	6.0	-	45	-	21.5	65	MKP1848550914K2
5	18.5	35.5	43.0	37.5	10.2	1.0	45	225	6.5	7	18.0	16.0	10	8.5	90	80	33	105	MKP1848550914P*
6	18.5	35.5	43.0	37.5	10.2	1.0	45	270	7	7.5	15.0	13.5	10	8.5	90	80	30	105	MKP1848560914P*
7	21.5	38.5	43.0	37.5	10.2	1.0	45	315	8	8.5	13.0	11.5	10	8.5	90	80	39	91	MKP1848570914P*
8	21.5	38.5	43.0	37.5	10.2	1.0	45	360	9	9.5	11.0	10.0	10	8.5	90	80	37	91	MKP1848580914P*
9	24.0	44.0	42.0	37.5	10.2	1.0	45	405	10	10.5	10.0	9.0	10	8.5	90	80	50	77	MKP1848590914P*
10	24.0	44.0	42.0	37.5	10.2	1.0	45	450	10.5	11	9.0	8.0	10	8.5	90	80	48	77	MKP1848610914P*
12	30.0	45.0	42.0	37.5	10.2/20.3	1.0	45	540	12.5	13.5	7.5	6.5	10	8.5	90	80	63	63	MKP1848612914P*
10	25.0	45.0	57.5	52.5	10.2	1.2	23	230	8	8.5	18.0	16.0	20	17	175	155	81	55	MKP1848610914Y*
12	25.0	45.0	57.5	52.5	10.2	1.2	23	276	8.5	9	15.0	13.0	20	17	175	155	77	55	MKP1848612914Y*
15	25.0	45.0	57.5	52.5	10.2	1.2	23	345	9.5	10.5	12.0	10.5	20	17	175	155	70	55	MKP1848615914Y*
20	30.0	45.0	57.5	52.5	20.3	1.2	23	460	11.5	12.5	9.0	8.0	20	17	175	155	91	45	MKP1848620914Y*
22	35.0	50.0	57.5	52.5	20.3	1.2	23	506	13.5	14.5	8.0	7.0	20	17	175	155	115	40	MKP1848622914Y*
25	35.0	50.0	57.5	52.5	20.3	1.2	23	575	14.5	15	7.0	6.5	20	17	175	155	108	40	MKP1848625914Y*
30	45.0	45.0	57.5	52.5	20.3	1.2	23	690	-	16.5	-	5.0	-	17	-	155	126	30	MKP1848630914Y5
60 (10)	70.0	65.0	57.5	52.5	20.3	1.2	23	1380	-	40	-	2.5	-	18	-	180	256	20	MKP1848660914Y5 (7)
70 (10)	70.0	65.0	57.5	52.5	20.3	1.2	23	1610	-	34.5	-	2.0	-	18	-	180	257	20	MKP1848670914Y5 (7)
120 (10)	130.0	65.0	57.5	52.5	20.3	1.2	23	2760	-	39.5	-	2.4	-	18	-	180	606	10	MKP1848712914Y5 (8)
140 (10)	130.0	65.0	57.5	52.5	20.3	1.2	23	3220	-	43.5	-	2	-	18	-	180	608	10	MKP1848714914Y5 (8)

Notes

- (1) Change the * symbol with special code for the terminals
- (2) Maximum RMS current at 10 kHz, + 85 °C, Δt = + 15 °C, Cap. tol. ≤ ± 5 %
- (3) Equivalent series resistance typical values at 10 kHz
- (4) Maximum tan δ values
- (5) Standard dimension
- (6) SPQ = Standard Packing Quantity
- (7) 6 pins
- (8) 12 pins
- (9) Intermediate capacitance values available on request.
- (10) Under release

SPECIFIC REFERENCE DATA 1200 V_{DC}

U_{NDC} at 85 °C = 1200 V, U_{OPDC} at 70 °C = 1500 V, U_{OPDC} at 105 °C = 850 V

CAP. (⁹)	DIMENSIONS (mm) (⁵)			P1	P2	Ø dt	dV/dt	I _{PEAK}	I _{RMS} (A) (²)		ESR (mΩ) (³)		tan δ 1 kHz < (10 ⁻⁴) (⁴)		tan δ 10 kHz < (10 ⁻⁴) (⁴)		MASS (g)	SPQ (⁵)	PART NUMBER (¹)
	(µF)	w	h						l	(mm)	(mm)	(mm)	(V/µs)	(A)	2 pins	4 pins			
1	11.0	21.0	32.0	27.5	-	0.8	100	100	3	-	43.0	-	6.0	-	40	-	9.0	130	MKP1848510924K2
2	15.0	25.0	32.0	27.5	-	0.8	100	200	5	-	21.5	-	6.0	-	40	-	11.5	100	MKP1848520924K2
3	18.0	28.0	32.0	27.5	-	0.8	100	300	6.5	-	14.5	-	6.0	-	40	-	15.0	80	MKP1848530924K2
4	21.0	31.0	32.0	27.5	-	0.8	100	400	8	-	11.0	-	6.0	-	40	-	20.0	65	MKP1848540924K2
5	18.5	35.5	43.0	37.5	10.2	1.0	48	240	6.5	7	17.0	15.0	10	8.5	80	70	31	105	MKP1848550924P*
6	18.5	35.5	43.0	37.5	10.2	1.0	48	288	7.5	8	14.0	12.5	10	8.5	80	70	29	105	MKP1848560924P*
7	21.5	38.5	43.0	37.5	10.2	1.0	48	336	8.5	9	12.0	11.0	10	8.5	80	70	37	91	MKP1848570924P*
8	21.5	38.5	43.0	37.5	10.2	1.0	48	384	9	9.5	10.5	9.5	10	8.5	80	70	35	91	MKP1848580924P*
9	24.0	44.0	42.0	37.5	10.2	1.0	48	432	10.5	11	9.5	8.5	10	8.5	80	70	48	77	MKP1848590924P*
10	24.0	44.0	42.0	37.5	10.2	1.0	48	480	11	11.5	8.5	7.5	10	8.5	80	70	45	77	MKP1848610924P*
12	30.0	45.0	42.0	37.5	10.2/ 20.3	1.0	48	576	13	13.5	7.0	6.5	10	8.5	80	70	60	63	MKP1848612924P*
10	25.0	45.0	57.5	52.5	10.2	1.2	24	240	8	8.5	17.0	15.0	18	16	165	150	79	55	MKP1848610924Y*
12	25.0	45.0	57.5	52.5	10.2	1.2	24	288	9	9.5	14.0	12.5	18	16	165	150	74	55	MKP1848612924Y*
15	25.0	45.0	57.5	52.5	10.2	1.2	24	360	10	10.5	11.0	10.0	18	16	165	150	67	55	MKP1848615924Y*
20	35.0	50.0	57.5	52.5	20.3	1.2	24	480	13	14	8.5	7.5	18	16	165	150	115	40	MKP1848620924Y*
22	35.0	50.0	57.5	52.5	20.3	1.2	24	528	14	14.5	7.5	7.0	18	16	165	150	109	40	MKP1848622924Y*
25	35.0	50.0	57.5	52.5	20.3	1.2	24	600	15	15.5	6.5	6.0	18	16	165	150	100	40	MKP1848625924Y*
30	45.0	45.0	57.5	52.5	20.3	1.2	24	720	-	16.5	-	5.0	-	16	-	150	119	30	MKP1848630924Y5
60 (¹⁰)	70.0	65.0	57.5	52.5	20.3	1.2	24	1440	-	23	-	4.5	-	17	-	170	264	20	MKP1848660924Y5 (⁷)
120 (¹⁰)	130.0	65.0	57.5	52.5	20.3	1.2	24	2280	-	40.5	-	2.3	-	17	-	170	612	10	MKP1848712924Y5 (⁸)

Notes

- (1) Change the * symbol with special code for the terminals
- (2) Maximum RMS current at 10 kHz, + 85 °C, Δt = + 15 °C, Cap. tol. ≤ ± 5 %
- (3) Equivalent series resistance typical values at 10 kHz
- (4) Maximum tan δ values
- (5) Standard dimension
- (6) SPQ = Standard Packing Quantity
- (7) 6 pins
- (8) 12 pins
- (9) Intermediate capacitance values available on request.
- (10) Under release

CONSTRUCTION DESCRIPTION

Low inductive wound cell elements of metallized polypropylene film, potted with resin in a flame retardant case.

Specific Method of Mounting to Withstand Vibration and Shock

The capacitor unit is designed for mounting on a printed circuit board.

In order to withstand vibration and shock tests, it must be insured that the stand-off pips are in good contact with the printed circuit board.

The capacitors shall be mechanically fixed by the leads and the body clamped.

Space Requirements on Printed-Circuit Board

The maximum length and width of film capacitors is shown in the figure:

- Product height with seating plane as given by "IEC 60717" as reference:

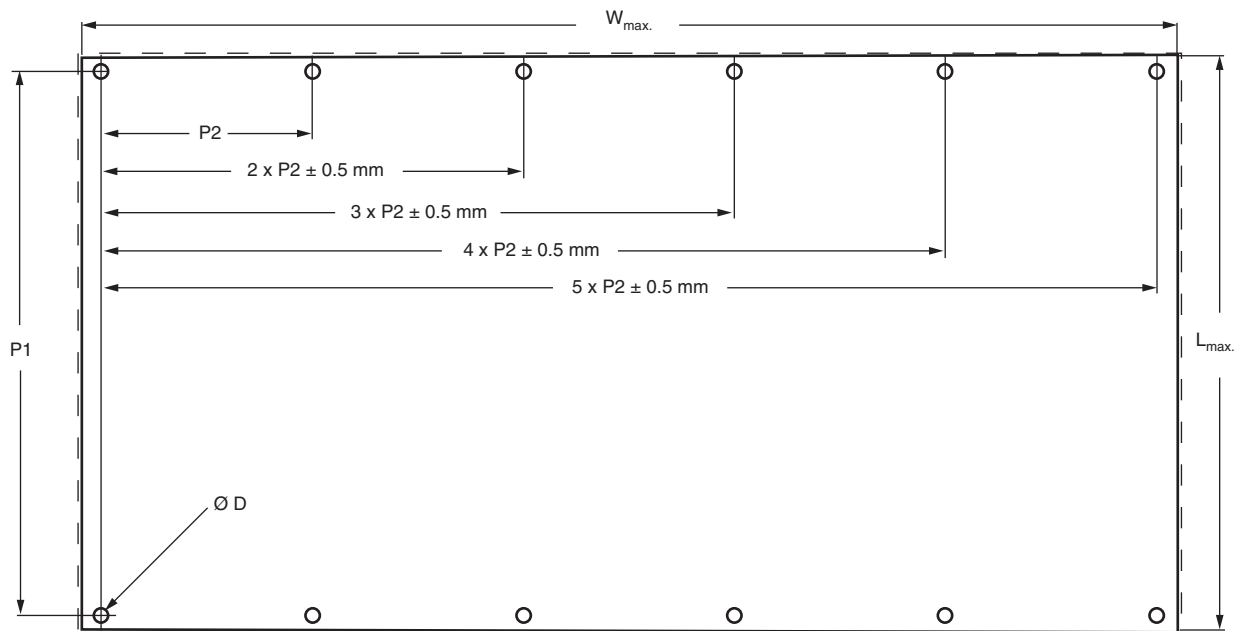

P1 (mm)	L _{max.} (mm)	W _{max.} (mm)	Ø D (mm)	H (mm)
27.5	l + 1.6	w + 2.0	1.2	h + 0.2
37.5	l + 2.0	w + 3.0	1.5	h + 0.5
52.5	l + 2.4	w + 4.0	1.7	h + 0.5

SOLDERING CONDITIONS

For general soldering conditions and wave soldering profile, we refer to the application note:

"Soldering Guidelines for Film Capacitors": www.vishay.com/doc?28171

Storage Temperature

- Storage temperature: T_{stg} = - 25 °C to + 40 °C with RH maximum 80 % without condensation.

Ratings and Characteristics Reference Conditions

Unless otherwise specified, all electrical values apply to an ambient temperature of 23 °C ± 1 °C, an atmospheric pressure of 86 kPa to 106 kPa and a relative humidity of 50 % ± 2 %.

For reference testing, a conditioning period shall be applied over 96 h ± 4 h by heating the products in a circulating air oven at the rated temperature and a relative humidity not exceeding 20 %.

CHARACTERISTICS

Capacitance (typical curve)

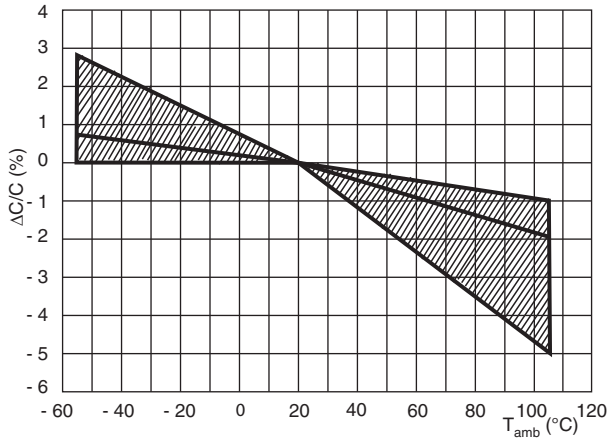

Insulation resistance (typical curve)

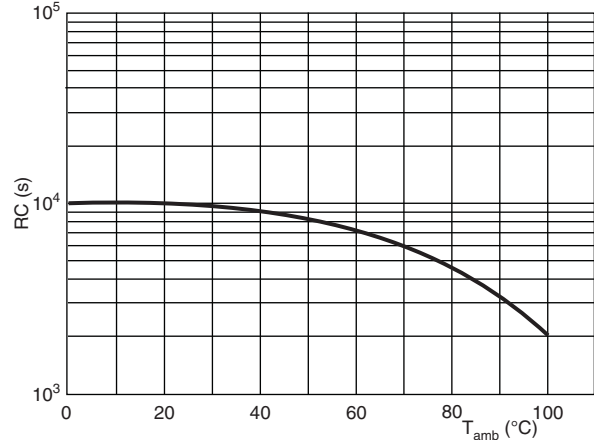

Lifetime expectancy (typical curve)

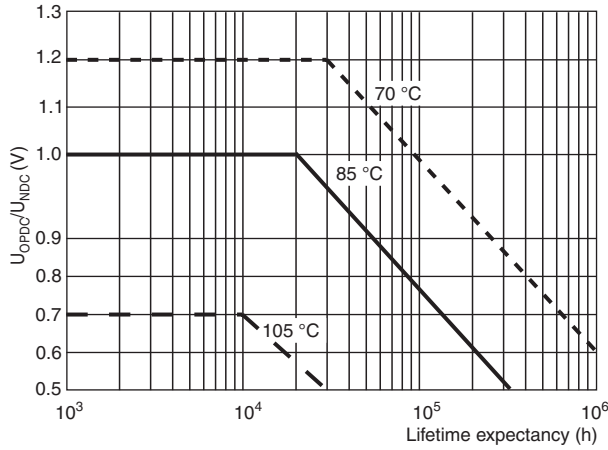

Impedance vs. frequency (typical curve)

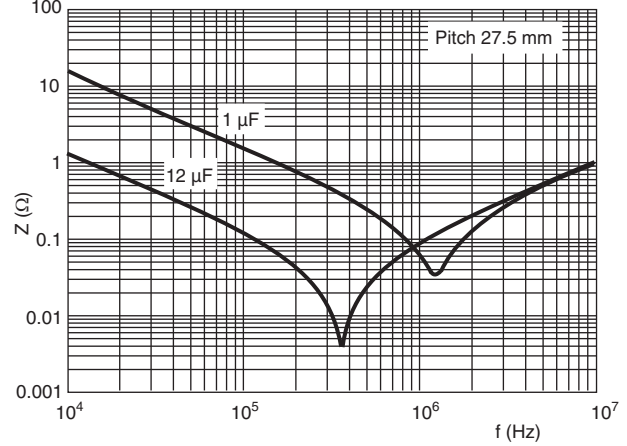

Impedance vs. frequency (typical curve)

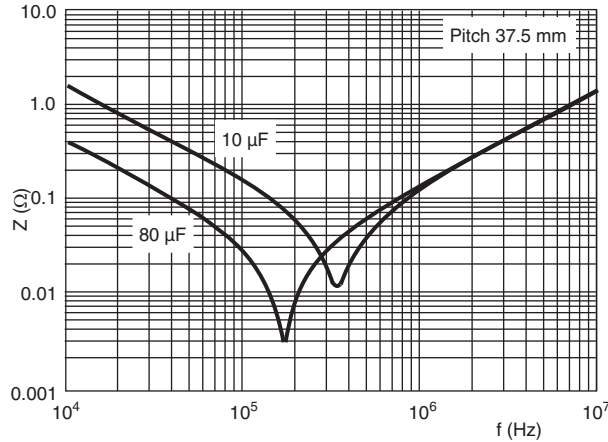

Impedance vs. frequency (typical curve)

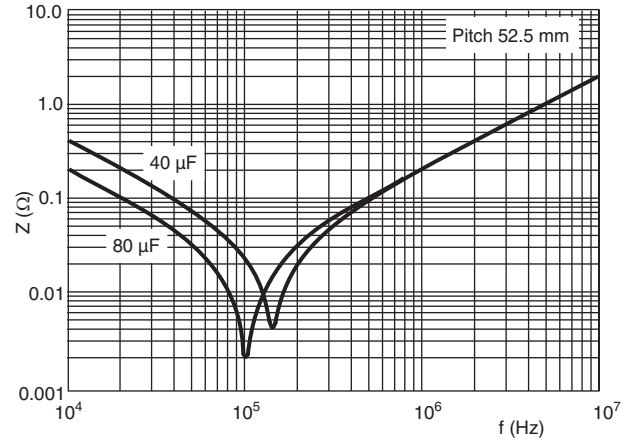

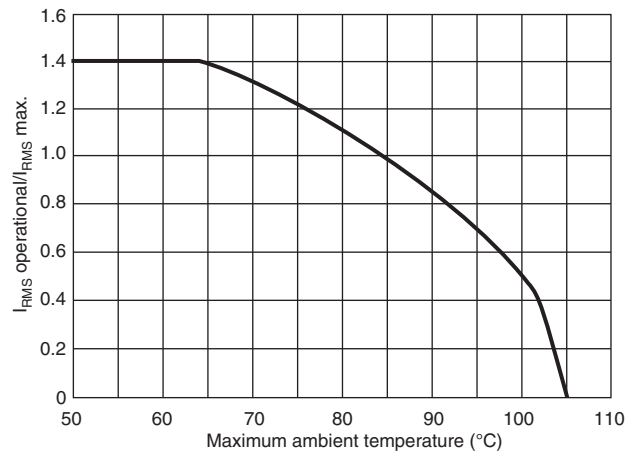
Maximum I_{RMS} current in function of the ambient temperature

HEAT CONDUCTIVITY

DIMENSIONS (mm)			HEAT CONDUCTIVITY (mW/°C)
w	h	l	
9.0	19.0	32.0	24
11.0	21.0	32.0	28
13.0	23.0	32.0	32
15.0	25.0	32.0	36
18.0	28.0	32.0	44
21.0	31.0	32.0	51
21.0	35.0	32.0	56
18.5	35.5	43.0	54
21.5	38.5	43.0	61
24.0	44.0	42.0	70
30.0	45.0	42.0	81
25.0	45.0	57.5	77
30.0	45.0	57.5	85
35.0	50.0	57.5	100
45.0	45.0	57.5	94
70.0	65.0	57.5	152
130.0	65.0	57.5	243

Power Dissipation and Maximum Component Temperature Rise

The power dissipation must be limited in order not to exceed the maximum allowed component temperature rise as a function of the free air ambient temperature.

The component temperature rise (ΔT) can be measured or calculated by $\Delta T = P/G$:

- $\Delta T = T_C - T_{amb}$ = case temperature rise (°C) with a maximum of 15 °C at rated temperature.
- $P = I_{RMS}^2$ = power dissipation of the component (mW)
- G = heat conductivity of the component (mW/°C)

MEASURING THE COMPONENT TEMPERATURE

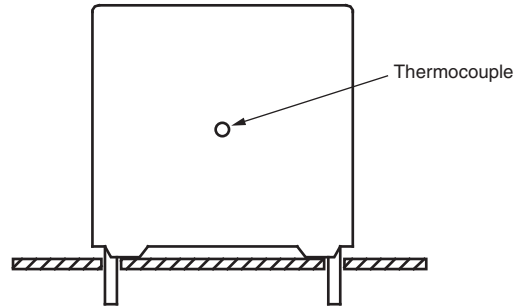

The case temperature is measured in unloaded (T_{amb}) and maximum loaded condition (T_C). To avoid thermal radiation or convection, the capacitor must be tested in a closed area from air circulation.

APPLICATION NOTE AND LIMITING CONDITIONS

These capacitors are not suitable for mains applications as across-the-line capacitors without additional protection. These mains applications are strictly regulated in safety standards and therefore electromagnetic interference suppression capacitors conforming the standards must be used.

To select the capacitor for a certain application, the following conditions must be checked:

- The continuous peak voltage (U_{P+}) shall not exceed the rated DC voltage rating (U_{NDC})
- The peak-to-peak ripple voltage (U_{PP}) shall not be greater than $0.2 \times (U_{NDC})$

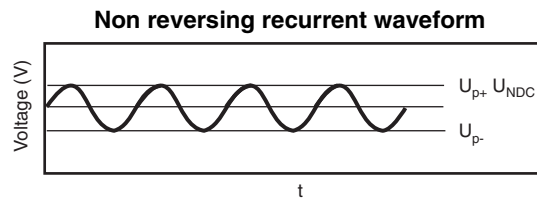

- For capacitors connected in parallel, normally the proof voltage and possibly the rated voltage must be reduced. For information depending of the capacitance value and the number of parallel connections contact: dc-film@vishay.com
- The voltage peak slope (dU/dt) shall not exceed the pulse slope at the DC voltage rating. If the pulse voltage is lower than the rated DC voltage, the rated voltage pulse slope may be multiplied by U_{Ndc} and divided by the applied voltage.

For all other pulses following equation must be fulfilled:

$$2 \times \int_0^T \left(\frac{dU}{dt} \right)^2 \times dt < U_{Ndc} \times \left(\frac{dU}{dt} \right)_{rated}$$

T is the pulse duration



Maximum Repetitive Peak Voltages

The capacitor unit may be subjected to the following surge without any significant reduction of lifetime expectancy

REPETITIVE SURGE VOLTAGE	MAXIMUM DURATION PER DAY
1.1 x U _{NDC}	30 % on load duration
1.15 x U _{NDC}	30 min
1.2 x U _{NDC}	5 min
1.3 x U _{NDC}	1 min
1.5 x U _{NDC}	110 ms

INSPECTION REQUIREMENTS

General Notes

Sub-clause numbers of tests and performance requirements refer to the “Sectional Specification, Publication IEC 61071”.

SUB-CLAUSE NUMBER AND TEST	CONDITIONS	PERFORMANCE REQUIREMENTS
ROUTINE TEST-FINAL INSPECTION		
5.14.2.1 External inspection, visual examination		Legible marking as specified
5.14.2.2 Dimensions		See specification drawing
5.3.1 Capacitance	1 kHz at room temperature	See specific reference data
5.3.2 tan δ	1 kHz at room temperature 10 kHz at room temperature	See specific reference data
5.5.1.2 Voltage test between terminal	1.5 x U _{NDC} at T _{amb} Duration 10 s	No visible damage or puncture No flashover
5.7 Insulation resistance	U _{NDC} ≤ 500 V measuring voltage 100 V at room temperature U _{NDC} > 500 V measuring voltage 500 V at room temperature Duration 1 min	See specific reference data
TYPE TESTS		
5.14.2 External inspection	Check for finish, marking and overall dimensions	Legible marking and finish as specified Dimensions: see specific drawing
5.14.0 Initial measurements	Capacitance at 1 kHz tan δ at 10 kHz	
5.14.1.1.4 Robustness of terminations IEC 60068-2-21	Tensile Ua1 Wire diameter section load ≤ 0.8 mm ≤ 0.5 mm ² 10 N ≤ 1.25 mm ≤ 1.2 mm ² 20 N Duration 10 s ± 1 s Bending Ub method 1 Wire diameter section load ≤ 0.8 mm ≤ 0.05 mm ³ 10 N ≤ 1.25 mm ≤ 0.019 mm ³ 20 N 4 x 90 °, Duration 2 s to 3 s/bend	
5.14.1.6 Resistance to soldering heat IEC 60068-2-20	No predrying, Method 1A Solder bath: 260 °C Duration 10 s ± 1 s	
5.14.4 Final measurements	Capacitance tan δ	ΔC/C ≤ 0.5 % Increase of tan δ ≤ 0.0050 Compared to values measured in 5.14.0
5.14.0 Initial measurements	Capacitance at 1 kHz tan δ at 10 kHz	

SUB-CLAUSE NUMBER AND TEST	CONDITIONS	PERFORMANCE REQUIREMENTS
5.14.3.1 Vibration IEC 60068-2-6	10 Hz to 55 Hz: amplitude ± 0.35 mm or acceleration 98 m/s^2 Test duration: 10 frequency cycles, 3 axes offset from each other by 90° 1 octave/min Visual examination	No visible damage
5.14.3.2 Shock or impact IEC 60068-2-6	Pulse shape: half sine Acceleration: 490 m/s^2 Duration t of pulse: 11 ms Visual examination	No visible damage
5.14.4 Final measurements	Capacitance $\tan \delta$	$ \Delta C/C \leq 0.5 \%$ Increase of $\tan \delta \leq 0.0050$ Compared to values measured in 5.14.0
5.5.3.1 Initial measurements	Capacitance at 1 kHz $\tan \delta$ at 10 kHz R insulation	$ \Delta C/C \leq 0.5 \%$ Increase of $\tan \delta \leq 1.2$ initial $\tan \delta + 0.0001$ R insulation $\geq 50 \%$ of specified values
5.5.3.2 Voltage test between terminal	$1.5 \times U_{\text{NDC}}$ at T_{amb} Duration 60 s	
5.5.3.3 Final measurements	Capacitance $\tan \delta$ R insulation	
5.9.1 Initial measurements	Capacitance at 1 kHz $\tan \delta$ at 10 kHz	$ \Delta C/C \leq 1.0 \%$ $\tan \delta \leq 1.2$ initial $\tan \delta + 0.0001$ Compared to values measured in 5.9.1
5.9.2 Surge discharge test	$1.1 \times U_{\text{NDC}}$ Number of discharges: 5 Time lapse: every 2 min (10 min total)	
5.9.3 Voltage test between terminal	Within 5 min after the surge discharge test Duration 60 s $1.5 \times U_{\text{NDC}}$ at T_{amb}	
5.9.3 Final measurements	Capacitance $\tan \delta$ at 10 kHz	
5.11.1 Initial measurements	Capacitance at 1 kHz $\tan \delta$ at 10 kHz	$ \Delta C/C \leq 0.5 \%$ $\tan \delta \leq 1.2 \times$ initial $\tan \delta + 0.0001$ Compared to values measured in 5.11.1
5.11.2 Self healing test	$1.5 \times U_{\text{NDC}}$ Duration 10 s Number of clearings ≤ 5 Clearing = voltage drop of 5 % increase the voltage at 100 V/s till 5 clearings occur with a max. of $2.5 \times U_{\text{NDC}}$ for a duration of 10 s	
5.11.3 Final measurements	Capacitance $\tan \delta$	
5.13.0 Initial measurements	Capacitance at 1 kHz $\tan \delta$ at 10 kHz	No puncturing or flashover Self healing punctures are permitted
5.13.1 Change of temperature acc. to IEC 60068-2-14	Test Nb $T_{\text{max.}} = 85 \text{ }^\circ\text{C}$ $T_{\text{min.}} = -40 \text{ }^\circ\text{C}$ Transition time: 1 h, equivalent to $1 \text{ }^\circ\text{C/min}$ 5 cycles	
5.13.2 Damp heat steady state Acc. to IEC 60068-2-78	Test Ca $T_{\text{max.}} = 40 \pm 2 \text{ }^\circ\text{C}$ RH = $93 \pm 3 \%$ Duration 56 days	
5.5.3.2 Voltage test between terminal	$1.5 \times U_{\text{NDC}}$ at ambient temperature Duration 60 s	
5.13.3 Final measurements	Visual examination	



Disclaimer

ALL PRODUCT, PRODUCT SPECIFICATIONS AND DATA ARE SUBJECT TO CHANGE WITHOUT NOTICE TO IMPROVE RELIABILITY, FUNCTION OR DESIGN OR OTHERWISE.

Vishay Intertechnology, Inc., its affiliates, agents, and employees, and all persons acting on its or their behalf (collectively, "Vishay"), disclaim any and all liability for any errors, inaccuracies or incompleteness contained in any datasheet or in any other disclosure relating to any product.

Vishay makes no warranty, representation or guarantee regarding the suitability of the products for any particular purpose or the continuing production of any product. To the maximum extent permitted by applicable law, Vishay disclaims (i) any and all liability arising out of the application or use of any product, (ii) any and all liability, including without limitation special, consequential or incidental damages, and (iii) any and all implied warranties, including warranties of fitness for particular purpose, non-infringement and merchantability.

Statements regarding the suitability of products for certain types of applications are based on Vishay's knowledge of typical requirements that are often placed on Vishay products in generic applications. Such statements are not binding statements about the suitability of products for a particular application. It is the customer's responsibility to validate that a particular product with the properties described in the product specification is suitable for use in a particular application. Parameters provided in datasheets and/or specifications may vary in different applications and performance may vary over time. All operating parameters, including typical parameters, must be validated for each customer application by the customer's technical experts. Product specifications do not expand or otherwise modify Vishay's terms and conditions of purchase, including but not limited to the warranty expressed therein.

Except as expressly indicated in writing, Vishay products are not designed for use in medical, life-saving, or life-sustaining applications or for any other application in which the failure of the Vishay product could result in personal injury or death. Customers using or selling Vishay products not expressly indicated for use in such applications do so at their own risk and agree to fully indemnify and hold Vishay and its distributors harmless from and against any and all claims, liabilities, expenses and damages arising or resulting in connection with such use or sale, including attorneys fees, even if such claim alleges that Vishay or its distributor was negligent regarding the design or manufacture of the part. Please contact authorized Vishay personnel to obtain written terms and conditions regarding products designed for such applications.

No license, express or implied, by estoppel or otherwise, to any intellectual property rights is granted by this document or by any conduct of Vishay. Product names and markings noted herein may be trademarks of their respective owners.