

Interference Suppression Film Capacitors MKP Radial Potted Type

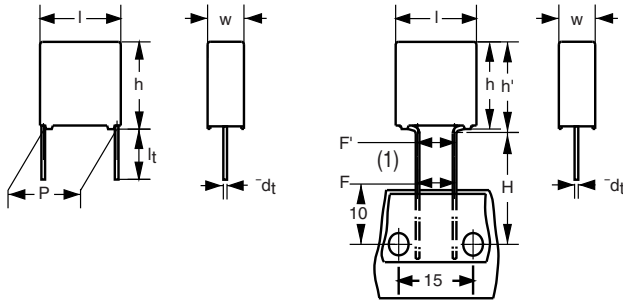

Dimensions in mm

Note

(1) $|F - F'| < 0.3 \text{ mm}$
 $F = 7.5 \text{ mm} + 0.6 \text{ mm} / - 0.1 \text{ mm}$

APPLICATIONS

For standard line bypass (between line and ground) Y2 applications

See also application note:

www.vishay.com/doc?28153

REFERENCE STANDARDS

“IEC 60384-14 ed-3 and EN 60384-14”
 “IEC 60065 requires, pass. flamm. class B”
 UL1414; CSA - C22.2 No. 1;
 UL1283; ENEC; CSA E 384-14-95

MARKING

C-value; tolerance; rated voltage; sub-class; manufacturer’s type designation; code for dielectric material, manufacturer location; manufacturer’s logo, year and week; safety approvals

DIELECTRIC

Polypropylene film

ELECTRODES

Metallized film

CONSTRUCTION

Series construction



Triple construction



RATED VOLTAGE

AC 300 V; 50 Hz to 60 Hz

FEATURES

- AEC-Q200 qualified
- 7.5 mm to 27.5 mm lead pitch, 15 mm and 10 mm bent back to 7.5 mm, supplied loose in box, taped on ammpack or reel
- Compliant to RoHS Directive 2002/95/EC

AUTOMOTIVE GRADE



RoHS COMPLIANT

PERMISSIBLE DC VOLTAGE

DC 1000 V

ENCAPSULATION

Plastic case, epoxy resin sealed, flame retardant class UL 94 V-0

CLIMATIC TESTING CLASS ACC. TO IEC 60068-1

55/105/56/B

CAPACITANCE RANGE (E12 SERIES)

E12 series 0.001 μF to 0.47 μF
 Preferred values acc. to E6

CAPACITANCE TOLERANCE

$\pm 20 \%$; $\pm 10 \%$; $\pm 5 \%$

LEADS

Tinned wire

MAXIMUM APPLICATION TEMPERATURE

105 °C

DETAIL SPECIFICATION

For more detailed data and test requirements contact:

RFI@vishay.com

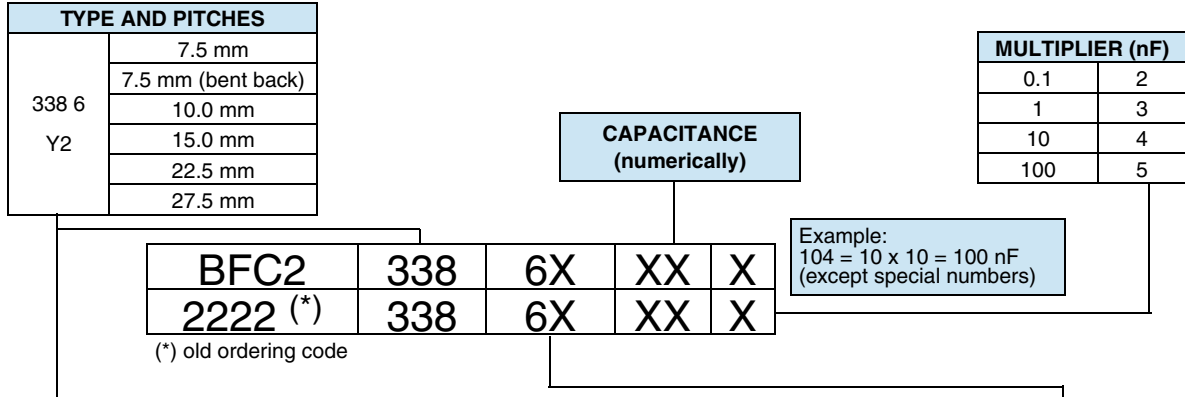
COMPOSITION OF CATALOG NUMBER

TYPE	PACKAGING	STANDARD DIMENSIONS	C-TOL	PREFERRED TYPES
338 6 Y2	Loose in box	Lead length 3.5 mm + 1 mm/- 0.5 mm (pitch 7.5 mm and 10 mm)	± 20 %	BFC2 338 60
		Lead length 3.5 mm ± 0.3 mm (pitch > 10 mm)		BFC2 338 62
Lead length 5.0 mm ± 1.0 mm		BFC2 338 64		
	Taped ammo	Lead length 25.0 mm ± 2.0 mm		BFC2 338 66
		Pitch = 7.5 mm H = 18.5 mm; P ₀ = 12.7 mm		
		ALTERNATIVE PITCH SIZES		ON REQUEST
338 6 Y2	Loose in box	Lead length 3.5 mm + 1 mm/- 0.5 mm (pitch 7.5 mm and 10 mm)	± 20 %	See tables for details
		Lead length 3.5 mm ± 0.3 mm (pitch > 10 mm)		
		Lead length 5.0 mm ± 1.0 mm		
		Lead length 25.0 mm ± 2.0 mm		
		ALTERNATIVE TAPED VERSION		ON REQUEST
338 6 Y2	Taped reel (1)	Pitch = 7.5 mm and 10.0 mm H = 18.5 mm; for P ₀ = 12.7 mm; reel diameter = 500 mm	± 20 %	See tables for details
		Pitch bent back to 7.5 mm H = 16.0 mm; P ₀ = 15.0 mm; reel diameter = 500 mm		
		ALTERNATIVE C-TOL		ON REQUEST
338 6 Y2	Loose in box	Lead length 3.5 mm + 1 mm/- 0.5 mm (pitch 7.5 mm and 10 mm)	± 10 %	See tables for details
		Lead length 3.5 mm ± 0.3 mm (pitch > 10 mm)	± 5 %	
		Lead length 5.0 mm ± 1.0 mm	± 10 %	
		Lead length 25.0 mm ± 2.0 mm	± 5 %	
	Taped ammo (1)	Pitch = 7.5 mm H = 18.5 mm; for P ₀ = 12.7 mm	± 10 %	
		Pitch bent back to 7.5 mm	± 5 %	
		H = 16.0 mm; P ₀ = 15.0 mm; reel diameter = 500 mm	± 10 %	
	Taped reel (1)	Pitch = 7.5 mm and 10.0 mm	± 10 %	
		H = 18.5 mm; P ₀ = 12.7 mm; reel diameter = 500 mm	± 5 %	

Note

 (1) For detailed tape specification refer to "Packaging Information" www.vishay.com/doc?28139
SPECIFIC REFERENCE DATA

DESCRIPTION	VALUE	
Rated AC voltage (U _{RAC})	300 V	
Permissible DC voltage (U _{RDC})	1000 V	
Tangent of loss angle	at 1 kHz	at 10 kHz
C ≤ 470 nF	≤ 10 x 10 ⁻⁴	≤ 20 x 10 ⁻⁴
Rated voltage pulse slope (dU/dt) _R at 420 V _{DC}	100 V/μs	
R between leads, for C ≤ 0.33 μF at 100 V; 1 min	> 15 000 MΩ	
RC between leads, for C > 0.33 μF at 100 V; 1 min	> 5000 s	
R between leads and case; 100 V; 1 min	> 30 000 MΩ	
Withstanding (DC) voltage (cut off current 10 mA) (1); rise time ≤ 1000 V/s	3400 V; 1 min	
Withstanding (AC) voltage between leads and case	2100 V; 1 min	
Maximum application temperature	105 °C	

Note

 (1) See "Voltage Proof Test for Metalized Film Capacitors": www.vishay.com/doc?28169

Vishay BCcomponents Interference Suppression Film Capacitors MKP Radial Potted Type

$U_{RAC} = 300\text{ V}$; $C\text{-tol} = \pm 20\%$ ($U_{RDC} = 1000\text{ V}$)

C (μF)	DIMENSIONS w x h x l (mm)	MASS (g) ⁽¹⁾	CATALOG NUMBER BFC2 338 6X XXX AND PACKAGING								
			LOOSE IN BOX					AMMOPACK		REEL 500 mm ⁽¹⁾⁽²⁾	
			Short leads			Long leads		H = 18.5 mm; P ₀ = 12.7 mm	SPQ	REEL: Ø = 500 mm H = 18.5 mm; P ₀ = 12.7 mm	SPQ
			$l_t = 3.5\text{ mm} + 1\text{ mm}/ - 0.5\text{ mm}$	$l_t = 5.0\text{ mm} \pm 1.0\text{ mm}$	SPQ	$l_t = 25.0\text{ mm} \pm 2.0\text{ mm}$	SPQ				
Pitch = 7.5 mm ± 0.4 mm; d_t = 0.50 mm ± 0.05 mm											
0.001	4.0 x 9.0 x 10.0	0.4	60102	62102	1500	64102	1000	66102	1250	68129	2500
0.0012			60122	62122		64122		66122		68131	
0.0015			60152	62152		64152		66152		68132	
0.0018			60182	62182		64182		66182		68133	
0.0022			60222	62222		64222		66222		68134	
0.0027			60272	62272		64272		66272		68135	
0.0033	5.0 x 10.5 x 10.0	0.4	60332	62332	1000	64332	1250	66332	1000	68136	2000
0.0039			60392	62392		64392		66392		68137	
0.0047	6.0 x 11.5 v 10.0	0.8	60472	62472	750	64472	1000	66472	750	68138	1900
0.0056			60562	62562		64562		66562		68139	
Pitch = 10.0 mm ± 0.4 mm; d_t = 0.60 mm ± 0.06 mm											
0.001	4.0 x 10.0 x 12.5	0.6	68392	68401	1000	68409	1250			68418	1400
0.0012			68393	68402		68411				68419	
0.0015			68394	68403		68412				68421	
0.0018			68395	68404		68413				68422	
0.0022			68396	68405		68414				68423	
0.0027			68397	68406		68415				68424	
0.0033			68398	68407		68416				68425	
0.0039			68399	68408		68417				68426	
0.0047	5.0 x 11.0 x 12.5	0.82	68101	68106	1000	68112	1000			68141	1100
0.0056			68102	68107		68113				68142	
0.0068			68103	68108		68114				68143	
0.0082	6.0 x 12.0 x 12.5	1.1	68104	68109	750	68115	750			68144	900
0.01			68105	68111		68116				68145	

Notes

- SPQ = Standard Packing Quantity

⁽¹⁾ H = In-tape height; P₀ = Sprocket hole distance; for detailed specifications refer to "Packaging Information"

⁽²⁾ Reel diameter = 365 mm is available on request

⁽³⁾ Weight for short lead product only



Interference Suppression Film Capacitors Vishay BCcomponents
MKP Radial Potted Type

C (µF)	DIMENSIONS w x h x l (mm)	MASS (g) ⁽¹⁾	CATALOG NUMBER BFC2 338 6X XXX AND PACKAGING								
			LOOSE IN BOX					AMMOPACK		REEL 500 mm ⁽¹⁾⁽²⁾	
			Short leads			Long leads		H = 18.5 mm; P ₀ = 12.7 mm	SPQ	REEL: Ø = 500 mm H = 18.5 mm; P ₀ = 12.7 mm	SPQ
			l _t = 3.5 mm + 1 mm/ - 0.5 mm	l _t = 5.0 mm ± 1.0 mm	SPQ	l _t = 25.0 mm ± 2.0 mm	SPQ				
Pitch = 15.0 mm ± 0.4 mm; d_t = 0.60 mm ± 0.06 mm											
0.0068	5.0 x 11.0 x 17.5	1.0	60682	62682	1000	64682	1000		68146	1100	
0.0082			60822	62822		64822			68147		
0.01			60103	62103		64103			68148		
0.012			60123	62123		64123			68149		
0.015	6.0 x 12.0 x 17.5	1.4	60153	62153	1000	64153	1000		68151	900	
0.018			60183	62183		64183			68152		
Pitch = 15.0 mm ± 0.4 mm; d_t = 0.80 mm ± 0.08 mm											
0.022	7.0 x 13.5 x 17.5	1.8	60223	62223	750	64223	500		68153	800	
0.027			60273	62273		64273			68154		
0.033	8.5 x 15.0 x 17.5	2.4	60333	62333	750	64333	500		68155	650	
0.039			60393	62393		64393			68156		
0.047	10.0 x 16.5 x 17.5	3.0	60473	62473	500	64473	450		68157	600	
0.056			60563	62563		64563			68158		
Pitch = 22.5 mm ± 0.4 mm; d_t = 0.80 mm ± 0.08 mm											
0.047	7.0 x 16.5 x 26.0	2.9	68123	68125	200	68127	250				
0.056			68124	68126		68128					
0.068	8.5 x 18.0 x 26.0	3.8	60683	62683	200	64683	250				
0.082			60823	62823		64823					
0.1	10.0 x 19.5 x 26.0	6.8	60104	62104	200	64104	200				
0.12	12.0 x 22.0 x 26.0	7.8	60124	62124	150	64124	200				
0.15			60154	62154		64154					
Pitch = 27.5 mm ± 0.4 mm; d_t = 0.80 mm ± 0.08 mm											
0.18	13.0 x 23.0 x 31.0	9.2	60184	62184	100	64184	125				
0.22			60224	62224		64224					
0.27	15.0 x 25.0 x 31.0	12.3	60274	62274	100	64274	125				
0.33	18.0 x 28.0 x 31.0	16.1	60334	62334	100	64334	100				
0.39			60394	62394		64394					
0.47	21.0 x 31.0 x 31.0	20.3	60474	62474	50	64474	75				

Notes

- SPQ = Standard Packing Quantity

⁽¹⁾ H = In-tape height; P₀ = Sprocket hole distance; for detailed specifications refer to "Packaging Information"

⁽²⁾ Reel diameter = 365 mm is available on request

⁽³⁾ Weight for short lead product only

Bent back pitch 7.5 mm

C (μ F)	DIMENSIONS w x h x l (mm)	MASS (g) ⁽¹⁾	CATALOG NUMBER BFC2 338 6X XXX AND PACKAGING								
			LOOSE IN BOX					AMMOPACK		REEL 500 mm ⁽¹⁾⁽²⁾	
			Short leads			Long leads		H = 16 mm; P ₀ = 15 mm	SPQ	REEL: Ø = 500 mm H = 16 mm; P ₀ = 15 mm	SPQ
			l _t = 3.5 mm + 1 mm/ - 0.5 mm	l _t = 5.0 mm ± 1.0 mm	SPQ	l _t = 25.0 mm ± 2.0 mm	SPQ				
Original pitch = 10.0 mm; bent back pitch = 7.5 mm ± 0.4 mm; d_t = 0.60 mm ± 0.06 mm											
0.001	4.0 x 12.0 x 12.5	0.6						68525	1300	68427	2000
0.0012								68526		68428	
0.0015								68527		68429	
0.0018								68528		68431	
0.0022								68529		68432	
0.0027								68531		68433	
0.0033								68532		68434	
0.0039								68533		68435	
0.0047	5.0 x 13.0 x 12.5	0.82						68534	1000	68117	1900
0.0056								68535		68118	
Original pitch = 15.0 mm; bent back pitch = 7.5 mm ± 0.4 mm; d_t = 0.60 mm ± 0.06 mm											
0.0068	5.0 x 13.0 x 17.5	1.1								66682	950
0.0082										66822	
0.01										66103	
0.012										66123	
0.015	6.0 x 14.0 x 17.5	1.4								66153	800
0.018										66183	
Original pitch = 15.0 mm; bent back pitch = 7.5 mm ± 0.4 mm; d_t = 0.80 mm ± 0.08 mm											
0.022	7.0 x 15.5 x 17.5	1.8								66223	700
0.027										66273	
0.033	8.5 x 17.0 x 17.5	2.4								66333	550
0.039										66393	
0.047	10.0 x 18.5 x 17.5	3.0								66473	500
0.056										66563	

Notes

- SPQ = Standard Packing Quantity
- ⁽¹⁾ H = In-tape height; P₀ = Sprocket hole distance; for detailed specifications refer to "Packaging Information"
- ⁽²⁾ Reel diameter = 365 mm is available on request
- ⁽³⁾ Weight for short lead product only



Interference Suppression Film Capacitors Vishay BCcomponents
MKP Radial Potted Type

U_{RAC} = 300 V; C-Tol = 10 % (U_{RDC} = 1000 V)

C (μF)	DIMENSIONS w x h x l (mm)	MASS (g) ⁽¹⁾	CATALOG NUMBER BFC2 338 6X XXX AND PACKAGING								
			LOOSE IN BOX					AMMOPACK		REEL 500 mm ⁽¹⁾⁽²⁾	
			Short leads			Long leads					
			l _t = 3.5 mm + 1 mm/ - 0.5 mm	l _t = 5.0 mm ± 1.0 mm	SPQ	l _t = 25.0 mm ± 2.0 mm	SPQ	H = 18.5 mm; P ₀ = 12.7 mm	SPQ	REEL: Ø = 500 mm H = 18.5 mm; P ₀ = 12.7 mm	SPQ
Pitch = 7.5 mm ± 0.4 mm; d_t = 0.50 mm ± 0.05 mm											
0.001	4.0 x 9.0 x 10.0	0.4	61102	63102	1500	65102	1000	67102	1250	68179	2500
0.0012			61122	63122		65122		67122		68181	
0.0015			61152	63152		65152		67152		68182	
0.0018			61182	63182		65182		67182		68183	
0.0022			61222	63222		65222		67222		68184	
0.0027			61272	63272		65272		67272		68185	
0.0033	5.0 x 10.5 x 10.0	0.4	61332	63332	1000	65332	1250	67332	1000	68186	2000
0.0039			61392	63392		65392		67392		68187	
0.0047	6.0 x 11.5 x 10.0	0.8	61472	63472	750	65472	1000	67472	750	68188	1900
0.0056			61562	63562		65562		67562		68189	
Pitch = 10.0 mm ± 0.4 mm; d_t = 0.60 mm ± 0.06 mm											
0.001	4.0 x 10.0 x 12.5	0.6	68436	68445	1000	68454	1250			68463	1400
0.0012			68437	68446		68455				68464	
0.0015			68438	68447		68456				68465	
0.0018			68439	68448		68457				68466	
0.0022			68441	68449		68458				68467	
0.0027			68442	68451		68459				68468	
0.0033			68443	68452		68461				68469	
0.0039			68444	68453		68462				68471	
0.0047	5.0 x 11.0 x 12.5	0.82	68159	68164	1000	68168	1000			68191	1100
0.0056			68161	68165		68169				68193	
0.0068	6.0 x 12.0 x 12.5	1.1	68162	68166	750	68171	750			68193	900
0.0082			68163	68167		68172				68194	

Notes

- SPQ = Standard Packing Quantity
- ⁽¹⁾ H = In-tape height; P₀ = Sprocket hole distance; for detailed specifications refer to "Packaging Information"
- ⁽²⁾ Reel diameter = 365 mm is available on request
- ⁽³⁾ Weight for short lead product only

C (μ F)	DIMENSIONS w x h x l (mm)	MASS (g) ⁽¹⁾	CATALOG NUMBER BFC2 338 6X XXX AND PACKAGING								
			LOOSE IN BOX					AMMOPACK		REEL 500 mm ⁽¹⁾⁽²⁾	
			Short leads			Long leads		H = 18.5 mm; P ₀ = 12.7 mm	SPQ	REEL: Ø = 500 mm H = 18.5 mm; P ₀ = 12.7 mm	SPQ
			l _t = 3.5 mm + 1 mm/ - 0.5 mm	l _t = 5.0 mm ± 1.0 mm	SPQ	l _t = 25.0 mm ± 2.0 mm	SPQ				
Pitch = 15.0 mm ± 0.4 mm; d_t = 0.60 mm ± 0.06 mm											
0.0068	5.0 x 11.0 x 17.5	1	61682	63682	1000	65682	1000		68202	1100	
0.0082			61822	63822		65822			68203		
0.01			61103	63103		65103			68204		
0.012			61123	63123		65123			68205		
0.015	6.0 x 12.0 x 17.5	1.4	61153	63153		65153			68206	900	
0.018			61183	63183		65183			68207		
Pitch = 15.0 mm ± 0.4 mm; d_t = 0.80 mm ± 0.08 mm											
0.022	7.0 x 13.5 x 17.5	1.8	61223	63223	750	65223	500		68208	800	
0.027	8.5 x 15.0 x 17.5	2.4	61273	63273		65273			68209	650	
0.033			61333	63333	65333	68211	650				
0.039	10.0 x 16.5 x 17.5	3	61393	63393	500	65393	450		68212	600	
0.047			61473	63473		65473			68213		
Pitch = 22.5 mm ± 0.4 mm; d_t = 0.80 mm ± 0.08 mm											
0.047	7.0 x 16.5 x 26.0	2.9	68173	68175	200	68177	250				
0.056	8.5 x 18.0 x 26.0	3.8	68174	68176		68178					
0.068			61683	63683	65683	68202					
0.082	10.0 x 19.5 x 26.0	6.8	61823	63823	150	65823	200				
0.1			61104	63104		65104					
0.12	12.0 x 22.0 x 26.0	7.8	61124	63124	150	65124	200				
0.15			61154	63154		65154					
Pitch = 27.5 mm ± 0.4 mm; d_t = 0.80 mm ± 0.08 mm											
0.18	13.0 x 23.0 x 31.0	9.2	61184	63184	100	65184	125				
0.22	15.0 x 25.0 x 31.0	12.3	61224	63224		65224					
0.27	18.0 x 28.0 x 31.0	16.1	61274	63274	50	65274	100				
0.33			61334	63334		65334					
0.39	21.0 x 31.0 x 31.0	20.3	61394	63394	50	65394	75				
0.47			61474	63474		65474					

Notes

- SPQ = Standard Packing Quantity

⁽¹⁾ H = In-tape height; P₀ = Sprocket hole distance; for detailed specifications refer to "Packaging Information"

⁽²⁾ Reel diameter = 365 mm is available on request

⁽³⁾ Weight for short lead product only



Bent back pitch 7.5 mm

C (μ F)	DIMENSIONS w x h x l (mm)	MASS (g) ⁽¹⁾	CATALOG NUMBER BFC2 338 6X XXX AND PACKAGING								
			LOOSE IN BOX					AMMOPACK		REEL 500 mm ⁽¹⁾⁽²⁾	
			Short leads			Long leads		H = 16 mm; P ₀ = 15 mm	SPQ	REEL: Ø = 500 mm H = 16 mm; P ₀ = 15 mm	SPQ
			$l_t = 3.5 \text{ mm} + 1 \text{ mm} / - 0.5 \text{ mm}$	$l_t = 5.0 \text{ mm} \pm 1.0 \text{ mm}$	SPQ	$l_t = 25.0 \text{ mm} \pm 2.0 \text{ mm}$	SPQ				
Original pitch = 10.0 mm; bent back pitch = 7.5 mm ± 0.4 mm; d_t = 0.60 mm ± 0.06 mm											
0.001 0.0012 0.0015 0.0018 0.0022 0.0027 0.0033 0.0039	4.0 x 12.0 x 12.5	0.6					68539 68541 68542 68543 68544 68545 68546 68547	1300	68472 68473 68474 68475 68476 68477 68478 68479	2000	
0.0047 0.0056	5.0 x 13.0 x 12.5	1.1					68548 68549	1000	68196 68197	1900	
Original pitch = 15.0 mm; bent back pitch = 7.5 mm ± 0.4 mm; d_t = 0.60 mm ± 0.06 mm											
0.0068 0.0082 0.01 0.012	5.0 x 13.0 x 17.5	1.0							67682 67822 67103 67123	950	
0.015 0.018	6.0 x 14.0 x 17.5	1.4							67153 67183	800	
Original pitch = 15.0 mm; bent back pitch = 7.5 mm ± 0.4 mm; d_t = 0.80 mm ± 0.08 mm											
0.022 0.027 0.033	7.0 x 15.5 x 17.5 8.5 x 17.0 x 17.5	1.8 2.4							67223 67273 67333	700 550	
0.039 0.047	10.0 x 18.5 x 17.5	3.0							67393 67473	500	

Notes

- SPQ = Standard Packing Quantity
- ⁽¹⁾ H = In-tape height; P₀ = Sprocket hole distance; for detailed specifications refer to "Packaging Information"
- ⁽²⁾ Reel diameter = 365 mm is available on request
- ⁽³⁾ Weight for short lead product only

Vishay BCcomponents Interference Suppression Film Capacitors MKP Radial Potted Type

$U_{RAC} = 300\text{ V}$; $C\text{-tol} = 5\%$ ($U_{RDC} = 1000\text{ V}$)

C (μF)	DIMENSIONS w x h x l (mm)	MASS (g) ⁽¹⁾	CATALOG NUMBER BFC2 338 6X XXX AND PACKAGING									
			LOOSE IN BOX					AMMOPACK		REEL 500 mm ⁽¹⁾⁽²⁾		
			Short leads			Long leads						
			$l_t = 3.5\text{ mm} + 1\text{ mm}/ - 0.5\text{ mm}$	$l_t = 5.0\text{ mm} \pm 1.0\text{ mm}$	SPQ	$l_t = 25.0\text{ mm} \pm 2.0\text{ mm}$	SPQ	H = 18.5 mm; P ₀ = 12.7 mm	SPQ	REEL: Ø = 500 mm H = 18.5 mm; P ₀ = 12.7 mm	SPQ	
Pitch = 7.5 mm ± 0.4 mm; d_t = 0.50 mm ± 0.05 mm												
0.001	4.0 x 9.0 x 10.0	0.4	68215	68225	1500	68235	1000	68335	1250	68346	2500	
0.0012			68216	68226		68236		68336		68347		
0.0015			68217	68227		68237		68337		68348		
0.0018			68218	68228		68238		68338		68349		
0.0022			68219	68229		68239		68339		68351		
0.0027	5.0 x 10.5 x 10.0	0.4	68221	68231	1000	68241	1250	68341	1000	68352	2000	
0.0033			68222	68232		68242		68342		68353		
0.0039	6.0 x 11.5 x 10.0	0.8	68223	68233	750	68243	1000	68343	750	68354	1900	
0.0047			68224	68234		68244		68344		68355		
Pitch = 10.0 mm ± 0.4 mm; d_t = 0.60 mm ± 0.06 mm												
0.001	4.0 x 10.0 x 12.5	0.6	68481	68489	1000	68498	1250			68507	1400	
0.0012			68482	68491		68499				68508		
0.0015			68483	68492		68501				68509		
0.0018			68484	68493		68502				68511		
0.0022			68485	68494		68503				68512		
0.0027			68486	68495		68504				68513		
0.0033			68487	68496		68505				68514		
0.0039			68488	68497		68506				68515		
0.0047	5.0 x 11.0 x 12.5	0.82	68245	68249	1000	68254	1000			68357	1100	
0.0056			68246	68251		68255				68358		
0.0068	6.0 x 12.0 x 12.5	1.1	68247	68252	750	68256	750			68359	900	
0.0082			68248	68253		68257				68361		

Notes

- SPQ = Standard Packing Quantity

⁽¹⁾ H = In-tape height; P₀ = Sprocket hole distance; for detailed specifications refer to "Packaging Information"

⁽²⁾ Reel diameter = 365 mm is available on request

⁽³⁾ Weight for short lead product only



Interference Suppression Film Capacitors Vishay BCcomponents
MKP Radial Potted Type

U_{RAC} = 300 V; C-tol = 5 % (U_{RDC} = 1000 V)

C (µF)	DIMENSIONS w x h x l (mm)	MASS (g) ⁽¹⁾	CATALOG NUMBER BFC2 338 6X XXX AND PACKAGING								
			LOOSE IN BOX					AMMOPACK		REEL 500 mm ⁽¹⁾⁽²⁾	
			Short leads			Long leads		H = 18.5 mm; P ₀ = 12.7 mm	SPQ	REEL: Ø = 500 mm H = 18.5 mm; P ₀ = 12.7 mm	SPQ
			l _t = 3.5 mm + 1 mm/ - 0.5 mm	l _t = 5.0 mm ± 1.0 mm	SPQ	l _t = 25.0 mm ± 2.0 mm	SPQ				
Pitch = 15.0 mm ± 0.4 mm; d_t = 0.60 mm ± 0.06 mm											
0.0068	5.0 x 11.0 x 17.5	1.0	68258	68284	1000	68309	1000		68381	1100	
0.0082			68259	68285		68311			68382		
0.01			68261	68286		68312			68383		
0.012	6.0 x 12.0 x 17.5	1.4	68262	68287		68313			68384	900	
0.015			68263	68288		68314			68385		
Pitch = 15.0 mm ± 0.4 mm; d_t = 0.80 mm ± 0.08 mm											
0.018	7.0 x 13.5 x 17.5	1.8	68264	68289	750	68315	500		68386	800	
0.022			68265	68291		68316			68387		
0.027	8.5 x 15.0 x 17.5	2.4	68266	68292		68317			68388		
0.033			68267	68293	68318	68389					
0.039	10.0 x 16.5 x 17.5	3.0	68268	68294	500	68319	450		68391	600	
Pitch = 22.5 mm ± 0.4 mm; d_t = 0.80 mm ± 0.08 mm											
0.047	7.0 x 16.5 x 26.0	2.9	68269	68295	200	68321	250				
0.056	8.5 x 18.0 x 26.0	3.8	68271	68296		68322					
0.068			68272	68297		68323					
0.082	10.0 x 19.5 x 26.0	6.8	68273	68298	150	68324	200				
0.1	12.0 x 22.0 x 26.0	7.8	68274	68299		68325					
0.12			68275	68301		68326					
Pitch = 27.5 mm ± 0.4 mm; d_t = 0.80 mm ± 0.08 mm											
0.15	13.0 x 23.0 x 31.0	9.2	68276	68302	100	68327	125				
0.18			68277	68303		68328					
0.22	15.0 x 25.0 x 31.5	12.3	68278	68304		68329					
0.27	18.0 x 28.0 x 31.5	16.1	68279	68305		68331	100				
0.33			68281	68306		68332					
0.39	21.0 x 31.0 x 31.0	20.3	68282	68307	50	68333	75				

Notes

- SPQ = Standard Packing Quantity

⁽¹⁾ H = In-tape height; P₀ = Sprocket hole distance; for detailed specifications refer to "Packaging Information"

⁽²⁾ Reel diameter = 365 mm is available on request

⁽³⁾ Weight for short lead product only

Bent back pitch = 7.5 mm

C (μ F)	DIMENSIONS w x h x l (mm)	MASS (g) ⁽¹⁾	CATALOG NUMBER BFC2 338 6X XXX AND PACKAGING								
			LOOSE IN BOX					AMMOPACK		REEL 500 mm ⁽¹⁾⁽²⁾	
			Short leads			Long leads		H = 16 mm; P ₀ = 15 mm	SPQ	REEL: Ø = 500 mm H = 16 mm; P ₀ = 15 mm	
			l _t = 3.5 mm + 1 mm/ - 0.5 mm	l _t = 5.0 mm ± 1.0 mm	SPQ	l _t = 25.0 mm ± 2.0 mm	SPQ			SPQ	
Original pitch = 10.0 mm; bent back pitch = 7.5 mm ± 0.4 mm; d_t = 0.60 mm ± 0.06 mm											
0.001	4.0 x 12.0 x 12.5	0.6						68553	1300	68516	2000
0.0012								68554		68517	
0.0015								68555		68518	
0.0018								68556		68519	
0.0022								68557		68521	
0.0027								68558		68522	
0.0033								68559		68523	
0.0039						68561	68524				
0.0047	5.0 x 13.0 x 12.5	0.82						68562	1000	68363	1900
0.0056								68563		68364	
Original pitch = 15.0 mm; bent back pitch = 7.5 mm ± 0.4 mm; d_t = 0.60 mm ± 0.06 mm											
0.0068	5.0 x 13.0 x 17.5	1.1								68368	950
0.0082										68369	
0.01										68371	
0.012	6.0 x 14.0 x 17.5	1.4								68372	800
0.015										68373	
Original pitch = 15.0 mm; bent back pitch = 7.5 mm ± 0.4 mm; d_t = 0.80 mm ± 0.08 mm											
0.018	7.0 x 15.5 x 17.5	1.8								68374	700
0.022										68375	
0.027	8.5 x 17.0 x 17.5	2.4								68376	550
0.033										68377	
0.039	10.0 x 18.5 x 17.5	3								68378	500

Notes

- SPQ = Standard Packing Quantity

⁽¹⁾ H = In-tape height; P₀ = Sprocket hole distance; for detailed specifications refer to "Packaging Information"

⁽²⁾ Reel diameter = 365 mm is available on request

⁽³⁾ Weight for short lead product only

APPROVALS

SAFETY APPROVALS Y2	VOLTAGE	VALUE	FILE NUMBERS
EN 60384-14 (ENEC) (= IEC 60384-14 ed-3)	300 V _{AC}	1 nF to 470 nF	FI 2008062 A1
UL1414 and CSA-C22.2 No 1 antenna coupling	250 V _{AC}	1 nF to 470 nF	E112471
UL1283	300 V _{AC}	1 nF to 470 nF	E109565
CSA-E384-14-95	300 V _{AC}	1 nF to 470 nF	1377022
CB-Test Certificate	300 V _{AC}	1 nF to 470 nF	FI 5265 A1
The EneC-approval together with the CB-Certificate replace all national marks of the following countries (they have already signed the ENEC-Agreement): Austria; Belgium; Czech. Republic; Denmark; Finland; France; Germany; Greece; Hungary; Ireland; Italy; Luxembourg; Netherlands; Norway; Portugal; Slovenian; Spain; Switzerland and United Kingdom.			

MOUNTING
Normal Use

The capacitors are designed for mounting on printed-circuit boards. The capacitors packed in bandoliers are designed for mounting in printed circuit boards by means of automatic insertion machines.

For detailed tape specifications refer to packaging information: www.vishay.com/doc?28139

Specific Method of Mounting to Withstand Vibration and Shock

In order to withstand vibration and shock tests, it must be ensured that the stand-off pips are in good contact with the printed-circuit board:

- For pitches ≤ 15 mm capacitors shall be mechanically fixed by the leads
- For larger pitches the capacitors shall be mounted in the same way and the body clamped

Space Requirements on Printed-Circuit Board

The maximum space for length ($l_{max.}$), width ($w_{max.}$), and height ($h_{max.}$) of film capacitors to take in account on the printed-circuit board is shown in the drawings:

- For products with pitch ≤ 15 mm, $\Delta w = \Delta l = 0.3$ mm; $\Delta h = 0.1$ mm
- For products with 15 mm $<$ pitch, ≤ 27.5 mm, $\Delta w = \Delta l = 0.5$ mm; $\Delta h = 0.1$ mm

Eccentricity defined as in drawing. The maximum eccentricity is smaller than or equal to the lead diameter of the product concerned.

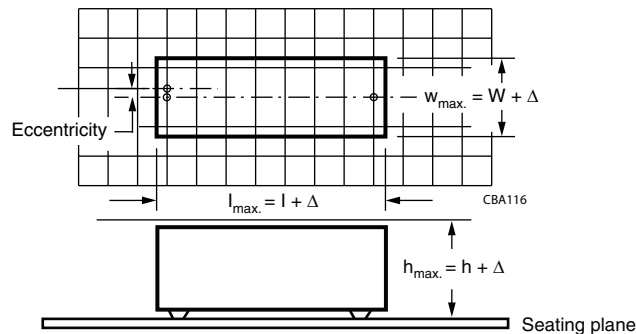
SOLDERING CONDITIONS

For general soldering conditions and wave soldering profile, we refer to the application note:

“Soldering Guidelines for Film Capacitors”: www.vishay.com/doc?28171

Storage Temperature

- Storage temperature: $T_{stg} = -25$ °C to $+40$ °C with RH maximum 80 % without condensation

Ratings and Characteristics Reference Conditions

Unless otherwise specified, all electrical values apply to an ambient temperature of 23 °C ± 1 °C, an atmospheric pressure of 86 kPa to 106 kPa and a relative humidity of 50 % ± 2 %.

For reference testing, a conditioning period shall be applied over 96 h ± 4 h by heating the products in a circulating air oven at the rated temperature and a relative humidity not exceeding 20 %.

CHARACTERISTICS

Capacitance as a function of ambient temperature
(typical curve)

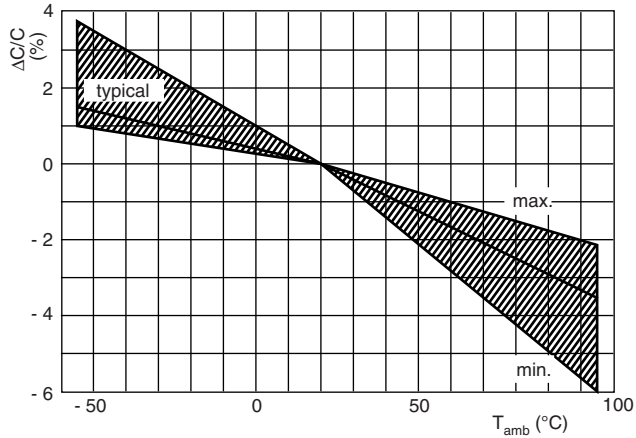

Tangent of loss angle as a function of frequency (typical curve)

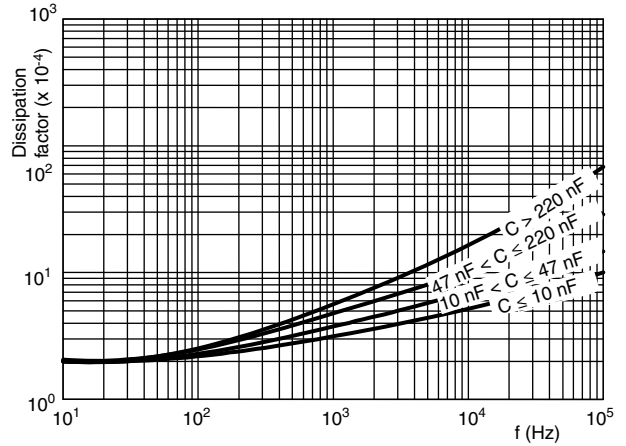

Impedance as a function of frequency (typical curve)

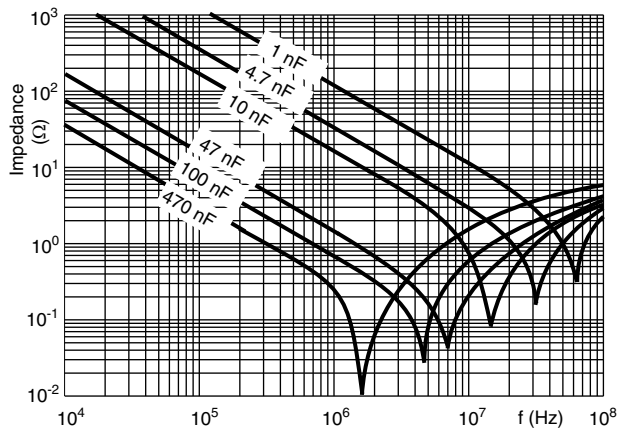

Resonant frequency as a function of capacitance (typical curve)

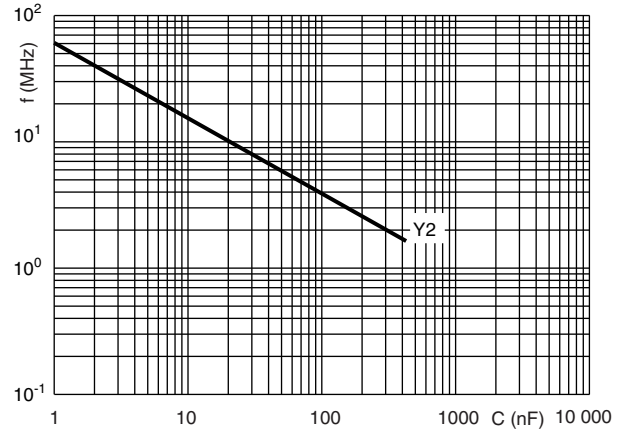

Max. RMS voltage as a function of frequency

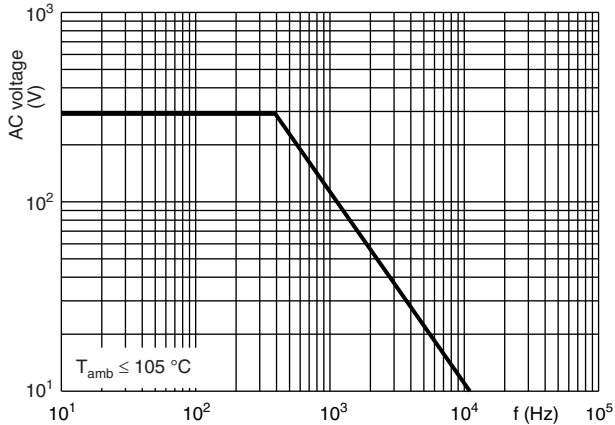

Max. RMS current as a function of frequency

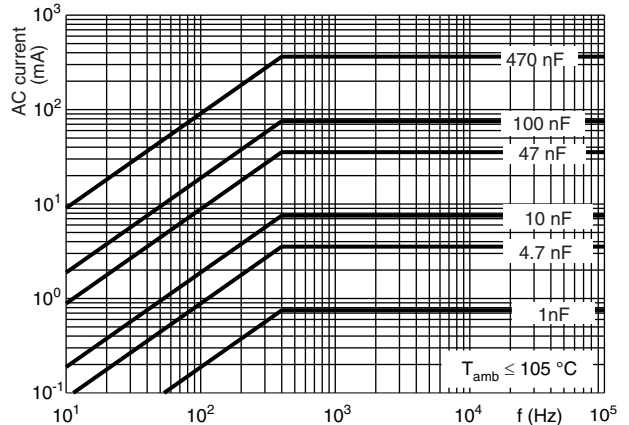

Insulation resistance as a function of ambient temperature

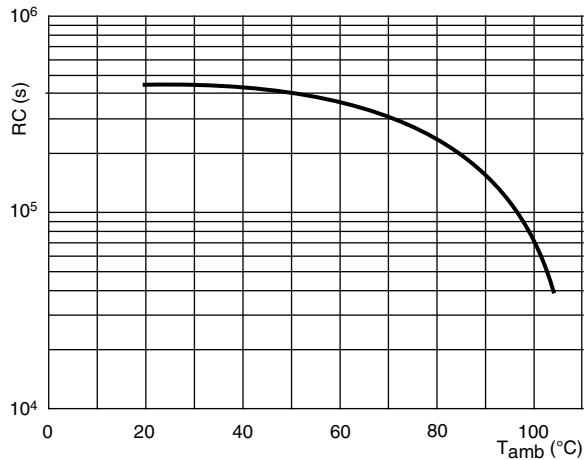

APPLICATION NOTES

- For X2 electromagnetic interference suppression in **standard across the line application** (50 Hz/60 Hz) with a maximum mains voltage of 310 V_{AC}
- For series impedance applications we refer to the “Application Note”: www.vishay.com/doc?28153
- For capacitors connected in parallel, normally the proof voltage and possibly the rated voltage must be reduced. For information depending of the capacitance value and the number of parallel connections contact: dc-film@vishay.com
- These capacitors are not intended for continuous pulse applications. For these situations, capacitors of the AC and pulse program must be used.
- The maximum ambient temperature must not exceed 110 °C (125 °C for less than 1000 h) for C ≤ 470 nF and 110 °C for C > 470 nF.
- Rated voltage pulse slope:
If the pulse voltage is lower than the rated voltage, the values of the specific reference data can be multiplied by 435 V_{DC} and divided by the applied voltage.

INSPECTION REQUIREMENTS

General Notes:

- Sub-clause numbers of tests and performance requirements refer to the "Sectional Specification, Publication IEC 60384-14 ed-3 and Specific Reference Data".

Group C Inspection Requirements

SUB-CLAUSE NUMBER AND TEST	CONDITIONS	PERFORMANCE REQUIREMENTS
SUB-GROUP C1A PART OF SAMPLE OF SUB-GROUP C1		
4.1 Dimensions (detail)		As specified in chapters "General Data" of this specification
Initial measurements	Capacitance Tangent of loss angle: at 10 kHz	
4.3 Robustness of terminations	Tensile: load 10 N; 10 s Bending: load 5 N; 4 x 90°	No visible damage
4.4 Resistance to soldering heat	No pre-drying Method: 1A Solder bath: 280 °C ± 5 °C Duration: 10 s	
4.19 Component solvent resistance	Isopropylalcohol at room temperature Method: 2 Immersion time: 5 min ± 0.5 min Recovery time: Min. 1 h, max. 2 h	
4.4.2 Final measurements	Visual examination	No visible damage Legible marking
	Capacitance	$ \Delta C/C \leq 5\%$ of the value measured initially
	Tangent of loss angle	Increase of $\tan \delta \leq 0.008$ Compared to values measured initially
	Insulation resistance	As specified in section "Insulation Resistance" of this specification



Interference Suppression Film Capacitors Vishay BCcomponents
MKP Radial Potted Type

SUB-CLAUSE NUMBER AND TEST	CONDITIONS	PERFORMANCE REQUIREMENTS
SUB-GROUP C1B PART OF SAMPLE OF SUB-GROUP C1		
Initial measurements	Capacitance Tangent of loss angle: at 10 kHz	
4.20 Solvent resistance of the marking:	Isopropylalcohol at room temperature Method: 1 Rubbing material: cotton wool Immersion time: 5 min ± 0.5 min	No visible damage Legible marking
4.6 Rapid change of temperature	θA = - 55 °C θB = + 105 °C 5 cycles Duration t = 30 min	
4.6.1 Inspection	Visual examination	No visible damage
4.7 Vibration	Mounting: see Section "Mounting" of this specification Procedure B4: Frequency range: 10 Hz to 55 Hz Amplitude: 0.75 mm or Acceleration 98 m/s ² (whichever is less severe) Total duration 6 h	
4.7.2 Final inspection	Visual examination	No visible damage
4.9 Shock	Mounting: see Section "Mounting" for more information Pulse shape: half sine Acceleration: 490 m/s ² Duration of pulse: 11 ms	
4.9.2 Final measurements	Visual examination	No visible damage
	Capacitance	ΔC/C ≤ 5 % of the value measured initially
	Tangent of loss angle	Increase of tan δ ≤ 0.008 Compared to values measured initially
	Insulation resistance	As specified in section "Insulation Resistance" of this specification

Vishay BCcomponents Interference Suppression Film Capacitors MKP Radial Potted Type

SUB-CLAUSE NUMBER AND TEST	CONDITIONS	PERFORMANCE REQUIREMENTS
SUB-GROUP C1 COMBINED SAMPLE OF SPECIMENS OF SUB-GROUPS C1A AND C1B		
4.11 Climatic sequence 4.11.1 Initial measurements 4.11.2 Dry heat 4.11.3 Damp heat cyclic Test Db First cycle 4.11.4 Cold 4.11.5 Damp heat cyclic Test Db remaining cycles 4.11.6 Final measurements	Capacitance Measured in 4.4.2 and 4.9.2 Tangent of loss angle: Measured initially in C1A and C1B Temperature: 105 °C Duration: 16 h Temperature: - 55 °C Duration: 2 h Visual examination Capacitance Tangent of loss angle Voltage proof 2250 V _{DC} ; 1 min between terminations Insulation resistance	No visible damage Legible marking $ \Delta C/C \leq 5\%$ of the value measured in 4.11.1. Increase of $\tan \delta \leq 0.008$ Compared to values measured in 4.11.1 No permanent breakdown or flash-over $\geq 50\%$ of values specified in section "Insulation Resistance" of this specification
SUB-GROUP C2		
4.12 Damp heat steady state 4.12.1 Initial measurements 4.12.3 Final measurements	56 days, 40 °C, 90 % to 95 % RH, no load Capacitance Tangent of loss angle at 1 kHz Visual examination Capacitance Tangent of loss angle Voltage proof 2250 V _{DC} ; 1 min between terminations Insulation resistance	No visible damage Legible marking $ \Delta C/C \leq 5\%$ of the value measured in 4.12.1. Increase of $\tan \delta \leq 0.007$ Compared to values measured in 4.12.1. No permanent breakdown or flash-over $\geq 50\%$ of values specified in section "Insulation Resistance" of this specification



Interference Suppression Film Capacitors Vishay BCcomponents
MKP Radial Potted Type

SUB-CLAUSE NUMBER AND TEST	CONDITIONS	PERFORMANCE REQUIREMENTS
SUB-GROUP C3		
4.13.1 Initial measurements	Capacitance Tangent of loss angle: at 10 kHz	
4.13 Impulse voltage	3 successive impulses, full wave, peak voltage: X1: 5 kV Max. 24 pulses	No selfhealing breakdowns or flash-over
4.14 Endurance	Duration: 1000 h 1.7 x U _{RAC} at 105 °C Once in every hour the voltage is increased to 1000 V _{RMS} for 0.1 s via resistor of 47 Ω ± 5 %	
4.14.7 Final measurements	Visual examination Capacitance Tangent of loss angle Voltage proof 2250 V _{DC} ; 1 min between terminations 2100 V _{AC} ; 1 min between terminations and case Insulation resistance	No visible damage Legible marking ΔC/C ≤ 10 % compared to values measured in 4.13.1. Increase of tan δ ≤ 0.008 Compared to values measured in 4.13.1. No permanent breakdown or flash-over ≥ 50 % of values specified in section "Insulation Resistance" of this specification
SUB-GROUP C4		
4.15 Charge and discharge	10 000 cycles charged to 420 V _{DC} Discharge resistance: $R = \frac{420 \text{ Vdc}}{1.5 \times C (dU/dt)}$	
4.15.1 Initial measurements	Capacitance Tangent of loss angle: at 10 kHz	
4.15.3 Final measurements	Capacitance Tangent of loss angle Insulation resistance	ΔC/C ≤ 10 % compared to values measured in 4.15.1. Increase of tan δ ≤ 0.008 Compared to values measured in 4.15.1. ≥ 50 % of values specified in section "Insulation Resistance" of this specification

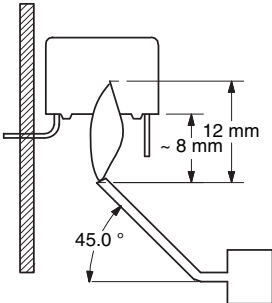
SUB-CLAUSE NUMBER AND TEST	CONDITIONS	PERFORMANCE REQUIREMENTS
SUB-GROUP C5		
4.16 Radio frequency characteristic	Resonance frequency	≥ 0.9 times the value as specified in section "Resonant Frequency" of this specification
SUB-GROUP C6		
4.17 Passive flammability Class B	<p>Bore of gas jet: \varnothing 0.5 mm Fuel: butane Test duration for actual volume V in mm³: V ≤ 250: 10 s 250 < V ≤ 500: 20 s 500 < V ≤ 1750: 30 s V > 1750: 60 s One flame application</p> 	After removing test flame from capacitor, the capacitor must not continue to burn for more than 10 s. No burning particle must drop from the sample.
SUB-GROUP C7		
4.18 Active flammability	20 cycles of 5 kV discharges on the test capacitor connected to U _{RAC}	The cheese cloth around the capacitors shall not burn with a flame. No electrical measurements are required.



Disclaimer

ALL PRODUCT, PRODUCT SPECIFICATIONS AND DATA ARE SUBJECT TO CHANGE WITHOUT NOTICE TO IMPROVE RELIABILITY, FUNCTION OR DESIGN OR OTHERWISE.

Vishay Intertechnology, Inc., its affiliates, agents, and employees, and all persons acting on its or their behalf (collectively, "Vishay"), disclaim any and all liability for any errors, inaccuracies or incompleteness contained in any datasheet or in any other disclosure relating to any product.

Vishay makes no warranty, representation or guarantee regarding the suitability of the products for any particular purpose or the continuing production of any product. To the maximum extent permitted by applicable law, Vishay disclaims (i) any and all liability arising out of the application or use of any product, (ii) any and all liability, including without limitation special, consequential or incidental damages, and (iii) any and all implied warranties, including warranties of fitness for particular purpose, non-infringement and merchantability.

Statements regarding the suitability of products for certain types of applications are based on Vishay's knowledge of typical requirements that are often placed on Vishay products in generic applications. Such statements are not binding statements about the suitability of products for a particular application. It is the customer's responsibility to validate that a particular product with the properties described in the product specification is suitable for use in a particular application. Parameters provided in datasheets and/or specifications may vary in different applications and performance may vary over time. All operating parameters, including typical parameters, must be validated for each customer application by the customer's technical experts. Product specifications do not expand or otherwise modify Vishay's terms and conditions of purchase, including but not limited to the warranty expressed therein.

Except as expressly indicated in writing, Vishay products are not designed for use in medical, life-saving, or life-sustaining applications or for any other application in which the failure of the Vishay product could result in personal injury or death. Customers using or selling Vishay products not expressly indicated for use in such applications do so at their own risk and agree to fully indemnify and hold Vishay and its distributors harmless from and against any and all claims, liabilities, expenses and damages arising or resulting in connection with such use or sale, including attorneys fees, even if such claim alleges that Vishay or its distributor was negligent regarding the design or manufacture of the part. Please contact authorized Vishay personnel to obtain written terms and conditions regarding products designed for such applications.

No license, express or implied, by estoppel or otherwise, to any intellectual property rights is granted by this document or by any conduct of Vishay. Product names and markings noted herein may be trademarks of their respective owners.